

# **777S User's Manual**



Nature Worldwide Technology Corp.

No. 1, Min-Chuan Street,

Tu-Cheng Industrial Park,

Taipei Hsien, Taiwan, R.O.C

Tel (886-2) 22689901

Fax (886-2) 22689903

[www.naturetech.com.tw](http://www.naturetech.com.tw)

---

## Copyright And Trademark Information

Copyright © 2001 by Nature Worldwide Technology Corp.

Copyright © 2001 by Sun Microsystems, Inc. 901 San Antonio Road, Palo Alto, CA 94303 USA.

All rights reserved. This product or document is protected by copyright and distributed under licenses restricting its use, copying, distribution and de-compilation. No part of this product or document may be reproduced in any form by any means without prior written authorization of Naturetech and its licensors, if any.

Portions of this product may be derived from the UNIX®, licensed from UNIX Systems Laboratories, Inc., a wholly owned subsidiary of Novell, Inc., and from the Berkeley 4.3 BSD system, licensed from the University of California. Third-party software, including font technology in this product, is protected by copyright and licensed from Sun's Suppliers.

### TRADEMARKS

Sun, Sun Microsystems, the Sun logo, OpenWindows, SunView, SunOS and Solaris are trademarks or registered trademarks of Sun Microsystems, Inc. UNIX and OPEN LOOK are registered trademarks of UNIX Systems Laboratories, Inc. All other product names mentioned herein are the trademarks of their respective owners.

All SPARC trademarks, including the SCD Compliant logo, are trademarks or registered trademarks of SPARC International, Inc. Products bearing SPARC trademarks are based upon an architecture developed by Sun Microsystems, Inc.

The OPEN LOOK® and Sun™ Graphical User Interfaces were developed by Sun Microsystems, Inc. for its users and licensees. Sun acknowledges the pioneering efforts of Xerox in researching and developing the concept of visual or graphical user interfaces for the computer industry. Sun holds a non-exclusive license from Xerox to the Xerox Graphical User Interface, which license also covers Sun's licensees who implement OPEN LOOK GUI's and otherwise comply with Sun's written License agreements. The X Window System is a trademark of X Consortium, Inc.

The trademarks, service marks or product names of their respective companies or organizations identify all other products or services mentioned herein.

---

**FCC Class B Notice**

This equipment has been tested and found to comply with the limits for a Class B digital device, pursuant to Part 15 of the FCC rules. These limits are designed to provide reasonable protection against harmful interference in a residential installation. This equipment generates, uses and can radiate radio frequency energy and, if not installed and used in accordance with the instructions, may cause harmful interference to radio communications. However, there is no guarantee that interference will not occur in a particular installation. If this equipment does cause harmful interference to radio or television reception, which can be determined by turning the equipment off and on, the user is encouraged to try to correct the interference by one or more of the following measures:

- Reorient or relocate the receiving antenna.
- Increase the separation between the equipment and receiver.
- Connect the equipment into an outlet on a circuit different from that to which the receiver is connected.
- Consult your supplier or an experienced radio or television technician for help.

Properly shielded and grounded cables and connectors must be used in order to meet FCC emission limits. Proper cables and connectors are available from your supplier. Nature Worldwide Technology is not responsible for any radio or television interference caused by using other than recommended cables and connectors or by unauthorized changes or modifications to this equipment. Unauthorized changes or modifications to the equipment could void the authority granted by the FCC to operate the equipment.

This device complies with Part 15 of the FCC rules. Operation is subject to the following two conditions: (1) this device may not cause harmful interference, and (2) this device must accept any interference received, including interference that may cause undesired operation.

**IMPORTANT NOTE:** To ensure compliance with the Class B limit, when this equipment is operated with an external video monitor, the cable used to connect between this equipment and the external monitor must be of a ferrite-loaded type. If the cable used is not already fitted with ferrite cores, the user must install a split ferrite core on the cable.

### **Canadian Department of Communications Compliance Statement**

This equipment does not exceed Class B limits per radio noise emissions for digital apparatus set out in the Radio Interference Regulations of the Canadian Department of Communications.

### **Avis de conformité aux normes du ministère des Communications du Canada**

Cet équipement ne dépasse pas les limites de Classe B d'émission de bruits radioélectroniques pour les appareils numériques, telles que prescrites par le Règlement sur le brouillage radioélectrique établi par le ministère des Communications du Canada.

### **Electrical Safety Notice**



Warning: THE AC ADAPTER SUPPLIED WITH YOUR COMPUTER CONTAINS DANGEROUS VOLTAGES. IT CONTAINS NO USER SERVICEABLE PARTS. DO NOT REMOVE THE COVER.



Warning: ELECTRICAL CURRENT FROM POWER, TELEPHONE AND COMMUNICATION CABLES IS HAZARDOUS. TO AVOID SHOCK HAZARD, CONNECT AND DISCONNECT CABLES AS DESCRIBED BELOW WHEN INSTALLING, MOVING OR OPENING THE COVERS OF THIS PRODUCT OR ATTACHED DEVICES.

### **Connect Peripheral Devices to Your Computer**

1. Turn your computer and peripherals OFF.
2. Connect all cables between your computer and any peripherals.
3. Connect all signal cables; for example, modem cable to a telephone receptacle.
4. Connect the power cord to the outlet.
5. Turn the peripherals ON and then turn your computer ON.

## Disconnect Peripherals Devices to Your Computer

1. Turn everything OFF.
2. Disconnect the power cord.
3. Disconnect the signal cables.
4. Disconnect all cables between your computer and peripherals.

## Lithium Ion Battery



Warning: THIS UNIT CONTAINS AN INTEGRATED LITHIUM BATTERY WHICH IS NOT A CUSTOMER SERVICEABLE PART AND MUST NOT BE REPLACED BY THE CUSTOMER / END USER. IF THE LITHIUM BATTERY REQUIRES REPLACEMENT, THE UNIT MUST BE RETURNED TO THE FACTORY OF MANUFACTURER, AS THERE IS A DANGER OF EXPLOSION IF THE BATTERY IS INCORRECTLY REPLACED.

## Environmental Notice



Note – The fluorescent lamp located in the liquid crystal display (LCD) contains a small amount of mercury. Dispose of it in accordance with your company's safety procedures, local procedures or return it to your supplier for safe disposal.

## Safety Instructions

1. Please read these safety instructions carefully.
2. Please keep this User's Manual for later reference.
3. Please disconnect this equipment from AC outlet before cleaning. Don't use liquid or sprayed detergent for cleaning. Use moist sheet or cloth for cleaning.
4. For pluggable equipment, the socket-outlet must be installed near the equipment and must be easily accessible.
5. Please keep this equipment from humidity.
6. Place this equipment on a reliable surface when installing. A drop or fall could cause injury.
7. Enclosure openings are for air circulation and protect the equipment from overheating. DO NOT COVER THE OPENINGS.
8. Make sure the voltage of the power source when connect the equipment to the power outlet.
9. Place the power cord so that it won't be stepped on or tripped over. Do not place anything on top of the power cord.
10. All cautions and warnings on the equipment should be noted.
11. If the equipment is not used for a long time, disconnect the equipment from outlet to avoid being damaged by transient over voltage.
12. Do not spill liquids onto equipment; this may cause fire or electrical shock.
13. Never open the equipment. For safety reasons, the equipment should only be opened by qualified service personnel.
14. If any of the following situations arises, have the equipment checked by qualified service:
  - A: The power cord or plug is damaged.
  - B: Liquid has penetrated into the equipment.
  - C: The equipment has been exposed to moisture.
  - D: The equipment does not work well or operation does not match behavior described in user's manual.
  - E: The equipment has been dropped or damaged.
  - F: The equipment has obvious signs of damage.
15. DO NOT LEAVE THIS EQUIPMENT IN AN ENVIRONMENT WHERE TEMPERATURES EXCEED 60 °C (140 °F); IT MAY DAMAGE THE EQUIPMENT.

## Wichtige Sicherheitshinweise

1. Bitte lesen Sie diese Hinweis sorgfaeltig durch.
2. Heben Sie diese Anleitung fuer den spaeteren Gebrauch auf.
3. Vor dem Reinigen ist das Geraet vom Stromnetz trennen.  
Verwenden Sie keine Fluessig-order Aerosolreiniger. Am besten eignet ein angefeuchtetes Tuch zur Reinigung.
4. Die Netzanschlusssteckdose soll nahe dem Geraet angebracht sind leicht zugaenglich sein.
5. Das Geraet ist vor Feuchtigkeit zu schuetzen.
6. Bei der Aufstellung des Geraetes ist auf sicheren Stand zu achten. Ein Kippen oder Fallen koennte Beschaedigungen hervorrufen.
7. Die Belueftungsoeffnungen dienen der Luftzirkulation, die das Geraet vor Ueberhitzung schuetzt. Sorgen Sie dafuer, dass diese Oeffnungen nicht abgedeckt werden.
8. Beachten Sie beim Anschluss an das Stromnetz die Anschlusswerte.
9. Verlegen Sie die Netzanschlussleitung so, dass niemand darueber fallen kann. Es sollte auch nichts auf der leitung abgestellt werden.
10. Alle Hinweise und Warnungen, die sich am Geraet befinden, sind zu beachten.
11. Wird das Geraet ueber einen laengeren Zeitraum nicht benutzt, sollten Sie es vom Stromnetz trennen. Somit wird im Falle einer Ueberspannung eine Beschaedigung vermieden.
12. Durch die Lueftungsoeffnungen duerfen niemals Gegenstaende oder Fluessigkeiten in das Geraet gelangen. Dies koennte einen Brand bzw. Elektrischen Schlag ausloesen.
13. Oeffnen Sie niemals das Geraet. Das Geraet darf aus Gruenden der elektrischen Sicherheit nur von autorisiertem Servicepersonal geoeffnet werden.
14. Wenn folgende Situationen auftreten ist das Geraet vom Stromnetz zu trennen und von einer qualifizierten Servicestelle zur Ueberpruefung:
  - A:Netzkabel oder Netzstecker sind beschaedigt.
  - B:Fluessigkeit ist in das Geraet eingedrungen.
  - C:Das geraet war Feuchtigkeit ausgesetzt.
  - D:Wenn das Geraet nicht der Bedienungsanleitung entsprechend funktioniert oder Sie mit Hilfe dieser nleitung keine Verbesserung erzielen.
  - E:Das Geraet ist gefallen.oder das Gehaeuse ist beschaedigt.
  - F:Wenn das Geraet deutliche Anzeichen eines Defektes aufweist.

# Contents

<b>Chapter 1 Welcome</b> .....	<b>17</b>
1.1 <i>Opening The Display Panel</i> .....	18
1.2 <i>Identifying External Components</i> .....	18
1.2.1 <i>Front View</i> .....	18
1.2.2 <i>Rear View</i> .....	20
1.2.3 <i>Left View</i> .....	22
1.2.4 <i>Bottom View</i> .....	23
<b>Chapter 2 Getting Started</b> .....	<b>25</b>
2.1 <i>Caring for the 777S</i> .....	26
2.2 <i>The Power System</i> .....	26
2.2.1 <i>AC Power System</i> .....	26
2.2.2 <i>Battery Power System</i> .....	26
2.2.2.1 <i>Battery Charging</i> .....	27
2.2.2.2 <i>Battery Warning Beep</i> .....	27
2.2.2.3 <i>Maximizing Battery Life</i> .....	28
2.2.2.4 <i>Operating On Internal Battery Power</i> .....	28
2.2.2.5 <i>Battery Behavior</i> .....	28
2.2.2.6 <i>Battery Conditioning</i> .....	29
2.3 <i>Installing/Removing The Battery Pack</i> .....	29
2.3.1 <i>Installing The Battery Pack</i> .....	29
2.3.2 <i>Removing The Battery Pack</i> .....	29
2.4 <i>Using the Power Adapter</i> .....	30
2.4.1 <i>The AC Adapter</i> .....	30
2.5 <i>Using and charging the battery</i> .....	31
2.6 <i>Powering ON your Computer</i> .....	31
2.7 <i>The Power-On Self Test</i> .....	32

---

2.8 Power Management System Operation .....	32
<b>Chapter 3 Using the Computer.....</b>	<b>33</b>
3.1 Keyboard .....	34
3.1.1 Embedded Numeric Keypad .....	34
3.1.2 Hot Keys .....	36
3.2 Pointing Device.....	37
3.2.1 Using the Touchpad .....	38
3.2.2 Caring for the Touchpad.....	39
3.3 Mouse or Keyboard Connection .....	40
3.3.1 Using An External Keyboard And Mouse .....	40
3.4 External Display Connections .....	41
3.5 External Audio Connections.....	41
3.5.1 Adjust Mic-In and Line-out.....	42
3.5.2 Using The Build-in Stereo Speaker .....	42
3.5.3 External Audio Outputs .....	43
3.6 Network Connections.....	43
3.6.1 Network Connection.....	44
3.7 System Memory Expansion .....	44
3.8 Securing Your Computer.....	45
3.9 LED Indicators.....	45
3.10 Using Serial Devices.....	47
3.10.1 Configuring Serial Connections.....	47
3.11 Using Parallel Devices.....	48
3.11.1 Configuring Parallel Devices.....	48

<b>Chapter 4 Security System</b> .....	<b>49</b>
4.1 Personal ID Security.....	50
4.1.1 Operation instruction .....	51
4.1.1.1 Create password: .....	51
4.1.1.2 Erase password:.....	51
4.1.2 Key combination.....	52
4.1.2.1 Single Key .....	52
4.1.2.2 Combination Key.....	53
4.2 Firmware Security (OBP) .....	53
4.2.1 Security Mode Commands.....	53
4.2.1.1 Command Security .....	53
4.2.1.2 Full Security.....	55
4.3 Software Security (Solaris).....	55
4.3.1 Setting Superuser Password.....	55
4.3.2 How to change Password .....	57
4.3.3 Administer Passwords .....	58
<b>Chapter 5 Initial System Configuration</b> .....	<b>61</b>
5.1 Overview of System Configuration.....	62
5.2 Initial Configuration.....	62
5.2.1 Select Locale .....	63
5.2.2 Configure network settings.....	64
5.2.3 Network Information .....	65
5.2.4 Internet Address .....	65
5.2.5 Subnets .....	66
5.2.6 Name Service .....	68
5.2.7 Time Zone .....	70
5.2.8 Date and Time settings .....	71
5.2.9 Setting A Superuser (root) Password .....	72
5.3 Create a User Account.....	74

5.3.1 User Name.....	75
5.3.2 User ID .....	75
5.3.3 Account Security .....	76
5.3.4 Home Directory .....	76
5.4 Restarting The System.....	76
<b>Chapter 6 Using the Network Interface .....</b>	<b>77</b>
6.1 Network Terminology.....	78
6.1.1 Client.....	78
6.1.2 DNS Domain Name Service (DNS) .....	78
6.1.2 Hostname .....	78
6.1.4 IP Address .....	78
6.1.5 NIS Network Information Service (NIS).....	78
6.1.6 Server .....	79
6.1.7 TCP/IP.....	79
6.2 An Overview of TCP/IP Networking and The Internet.....	79
6.2.1 Internet Addresses .....	79
6.2.2 Classes Of Address.....	80
6.2.3 Addresses Used By Systems Not Connected To The Internet.....	81
6.2.4 Network Names.....	81
6.2.5 Accessing The Internet.....	82
6.2.6 Registering Internet Addresses.....	82
6.3 Configuring 777S for a TCP/IP Network.....	82
6.3.1 Assigning a Hostname and IP Address .....	83
6.3.2 Configuring 777S to use a Name Server.....	84
6.3.3 Setting up a Default Router.....	85
6.3.4 Testing Your Network Connection.....	85
6.4 Sharing Filesystems .....	86
6.4.1 Exporting Local Filesystems.....	86
6.4.2 Mounting Filesystems .....	88
6.4.3 Automatic File Mounting .....	88
6.4.4 Unmounting a Remote Filesystem.....	89
6.5 Executing Remote Commands .....	90

---

6.5.1 Copying Files.....	90
6.5.2 Remote Program Execution .....	90
6.5.3 PPP.....	91
<b>Chapter 7 Remote Computing .....</b>	<b>93</b>
7.1 Getting Connected.....	94
7.1.1 Checking modem status .....	94
7.2 Simple Terminal Login Connection.....	94
7.3 Remote Network Access .....	95
7.4 Setting Up PPP .....	96
7.4.1 Starting And Stopping PPP .....	97
7.4.2 Testing The Link .....	97
7.5 Electronic Mail.....	97
7.5.1 Setting Up Email .....	97
7.6 AT Command Set.....	98
7.6.1 AT Command Set Description.....	99
7.7 Class 2 Fax Command Set .....	103
<b>Chapter 8 Installing and Using Applications.....</b>	<b>105</b>
8.1 Third-Party Application Support.....	106
8.2 Methods Of Installing Applications.....	106
8.3 Applications And Graphics Interfaces .....	107
8.4 Legibility Of Text On A Small Screen.....	107
8.5 Customizing the Operating System.....	108
8.5.1 Installing Packages .....	108
8.5.2 Displaying Package Information .....	110

8.5.3 Removing Packages .....	110
<b>8.6 Memory Usage And Swap Space .....</b>	<b>110</b>
8.6.1 Using Swap Space Efficiently .....	111
8.6.2 Checking Swap Space Usage .....	112
8.6.3 Adding Swap Space .....	112
<b>Chapter 9 System Backup and Restore .....</b>	<b>113</b>
9.1 Overview .....	114
9.1.1 Backup Strategies .....	114
9.1.2 Further Information .....	114
9.2 File Backup Facilities .....	114
9.3 Backing Up Filesystems .....	115
9.3.1 Backing Up Onto 2 <sup>nd</sup> Hard Drive .....	115
9.4 Restoring Filesystems .....	116
<b>Chapter 10 System Upgrade Information .....</b>	<b>119</b>
10.1 Overview .....	120
10.2 Upgrading The Main Memory .....	120
10.2.1 Memory upgrade notice .....	120
10.2.2 Upgrade Memory .....	121
10.2.3 Remove the memory module .....	121
10.2.4 Upgrade Memory .....	122
10.2.5 Checking the memory capacity .....	123
10.3 Upgrading Solaris™ .....	123
10.4 Upgrading Firmware .....	123
<b>Chapter 11 Troubleshooting .....</b>	<b>127</b>
11.1 Getting Help .....	128

---

11.1.1 Contacting Customer Support .....	128
<b>11.2 Problem description &amp; solution.....</b>	<b>129</b>
11.2.1 Startup Problems .....	129
11.2.2 Network Problems .....	130
<b>11.3 Hardware Problems.....</b>	<b>131</b>
11.3.1 Display Problems .....	131
11.3.2 I/O Problems .....	131
<b>11.4 Using The OpenBoot Diagnostics tool .....</b>	<b>131</b>
11.4.1 Displaying The OpenBoot User Interface .....	132
11.4.2 Checking IDE devices .....	132
11.4.3 Checking The Network Interface .....	132
11.4.4 Full System Hardware Self test.....	133
<b>11.5 Software Problems.....</b>	<b>134</b>
11.5.1 Stopping Processes.....	134
11.5.2 Killing a Program .....	135
11.5.3 Operating System Panic .....	135
11.5.4 Warning Messages.....	136
<b>11.6 Resetting 777S .....</b>	<b>137</b>

## About this Manual

This Manual describes how to use the 777S. It describes operation instruction about start up/shutdown system and how to use accessories. Chapter 1 to chapter 5 describe basic information for 777S, read these chapter will help you to realize basic operation information for 777S and achieve basic knowledge to use this machine without problem as soon as possible.

This section provides the following information:

- Models Covered By This Manual
- Related Documents
- Typographical Conventions
- Shell Prompts

## Related Documentation

Publication	Topics
<b>Read Me First</b>	Release notes for the version of Solaris™ currently offered for 777S.
<b>777S Technical Reference Manual</b>	Provide basic skill for qualify technician to maintain/repair 777S.

## Typographical Conventions

A number of typographical conventions are used in this publication to aid your understanding. These are summarized as follows:

Typeface	Meaning	Example
Monospace	Used to indicate text displayed on screen and OS file names.	... the device file /dev/rdiskette.
Monospace Bold	Used to indicate commands you type in.	# more /etc/hostts
Sans-serif Bold	Used to indicate particular keys or key sequences that you press on the keyboard, and buttons displayed in windows.	To power off, press the Power button.
<i>Italics</i>	Used to emphasize important terms when they are first used and for titles of other publications.	The term <i>domain</i> is often applied to a group of networked computers within an organization.

## Shell Prompts

Shell	Prompt
C shell	machine_name%
C shell superuser	machine_name#
Bourne shell and Korn shell	\$
Bourne shell and Korn shell superuser	#

## Chapter 1 Welcome

## 1.1 Opening The Display Panel

Refer to the figure below; you can see the display release latch located on the front panel to secure the display panel. Push on the latch outward as arrow below to open the display panel. Gently tilt the display panel forward or backward to the best viewing angle.

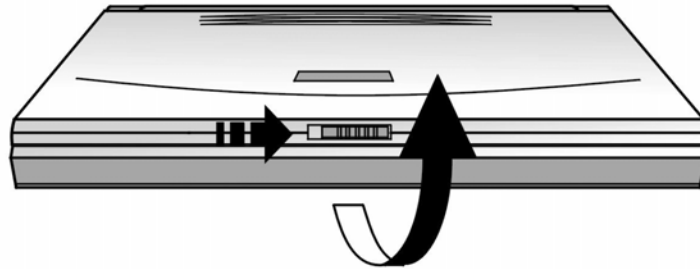

## 1.2 Identifying External Components

Refer to following sections to identify all external components and accessories on the 777S.

### 1.2.1 Front View

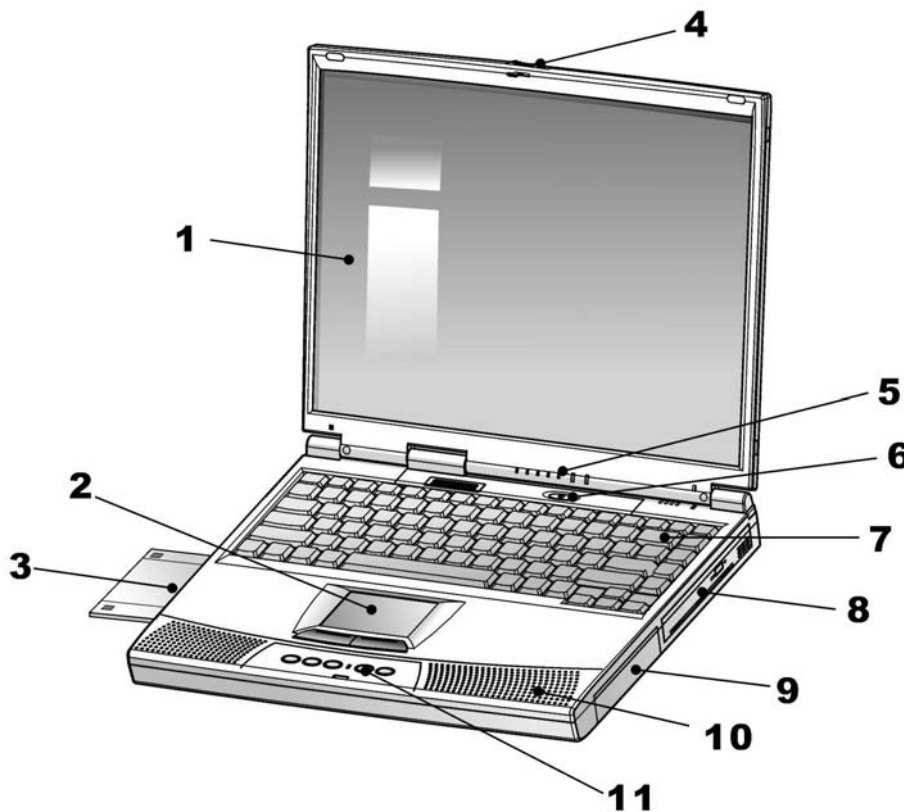

Front View of 777S

**1. Display—15" XGA TFT LCD Screen**

The 777S uses a 15" TFT XGA LCD panels supporting resolutions up to 1024 x 768.

**2. Touchpad**

The pressure sensitive Touchpad provides all the functions of a two-button mouse and **can not** be used simultaneously with an external USB mouse.

**3. Built-in FDD Module**

777S uses a standard floppy module that accepts 1.44MB or 720KB 3.5-inch floppy diskettes.

**The floppy drive is removable and can be swapped with 2<sup>nd</sup> hard drive or 2<sup>nd</sup> battery. (Optional)**

**4. Display Panel Latch**

This latches is used to secure the display panel. When the 777S not in use, keep the display panel closed, this latch will lock the display panel to prevent dust accumulation.

**5. System Status LEDs**

These LEDs indicates the computer's current operating status.

**6. Power Button**

The power button allows power on/off system. If you're running Solaris, you must log out Solaris environment completely and jump to ok prompt then use this button to turn off system.

**7. Keyboard**

The low-profile keyboard emulates all the functions of a full-size Sun keyboard including an embedded keypad and a full array of special function keys. The keyboard provide Solaris™ function keys to help ease navigation in the Solaris™ operating system.

**8. DVD ROM Module**

The 777S comes with an enhanced IDE 5.25-inch DVD-ROM drive.

**9. Battery Module**

Lithium-Ion Battery Module.

## 10. Built-in Stereo Speakers

## 11. Personal ID Security for password and launch key.

5 button pure hardware solution, 800K possible combination passwords.

### 1.2.2 Rear View

The following figure describes all the components on the rear side of 777S.

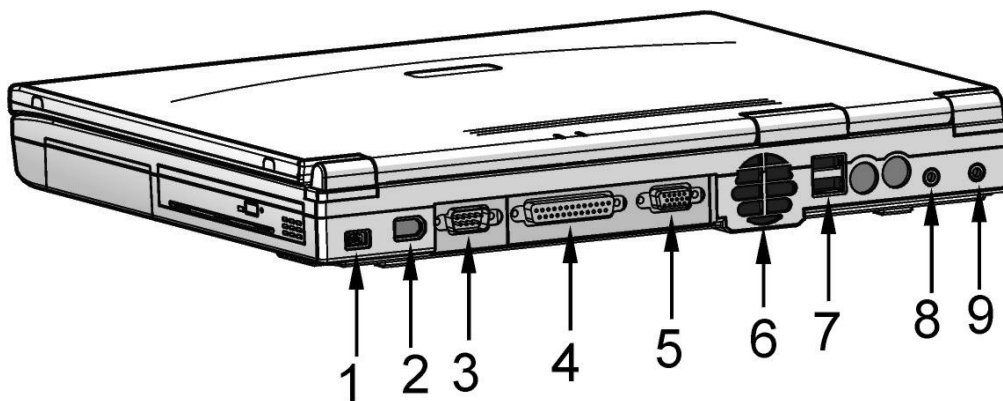

Rear View of 777S

#### 1. DC-In Jack

The DC power input jack allows connecting a power adapter which converts AC power to DC power for computer use.

#### 2. IEEE 1394 (FireWire) Port

The 777S will provides one, 6-pin, IEEE-1394 interface for faster asynchronous peripheral devices supporting transfer rates up to 400Mb/s. **The interface is currently not available to be support, it would be provided in the near future.**

#### 3. Serial Port

This 9-pin serial port supports RS-232 devices such as data terminal or external serial modem.

**4. Parallel (LPT1) Port**

IEEE-1284 compliant bidirectional parallel port. This 25-pin parallel port supports parallel devices such as a parallel port printer.

**5. CRT Port**

This 15-pin CRT port supports standard VGA-compatible devices such as an external CRT monitor or projector.

**6. Air Vent**

This area will bring the heat out for heat exchange.

**7. USB Ports**

These Universal Serial Bus ports were designed in full compliance with the Universal Serial Bus specification 1.0.

**8. Audio Line Out Jack**

This stereo jack is used for connecting external stereo speakers or headphones.

**9. Audio Mic-In Jack**

This Mic-in jack is used to connect an external microphone.

### 1.2.3 Left View

The figure below describes all external components and accessories on the front left view of the computer.

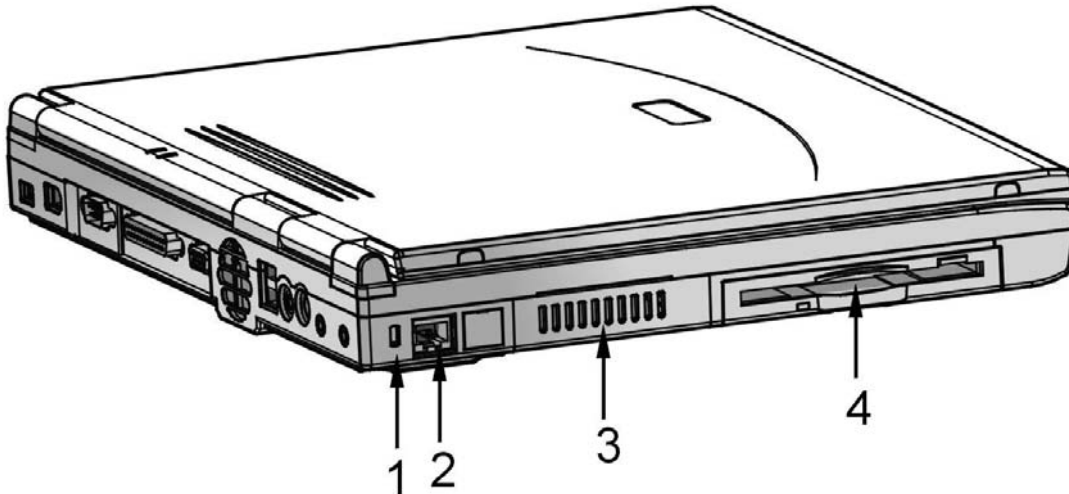

Front Left View of 777S

#### 1. Security Lock port

The security lock port allows to use the security Lock to lock your computer to a desk or other fixed object to prevent the computer from being removed.

#### 2. Built-In RJ-45 Ethernet Jack

The internal Ethernet supports 10Base-T or 100Base-TX standard networks.

#### 3. Air Vent

This area will bring the heat out for heat exchange.

#### 4. Built-in FDD Module

777S uses a standard floppy module that accepts 1.44MB or 720KB 3.5-inch floppy diskettes.

**The floppy drive is removable and can be swapped with 2<sup>nd</sup> hard drive or 2<sup>nd</sup> battery. (Optional)**

---

### 1.2.4 Bottom View

---

The figure below describes all the components on the bottom of the computer.

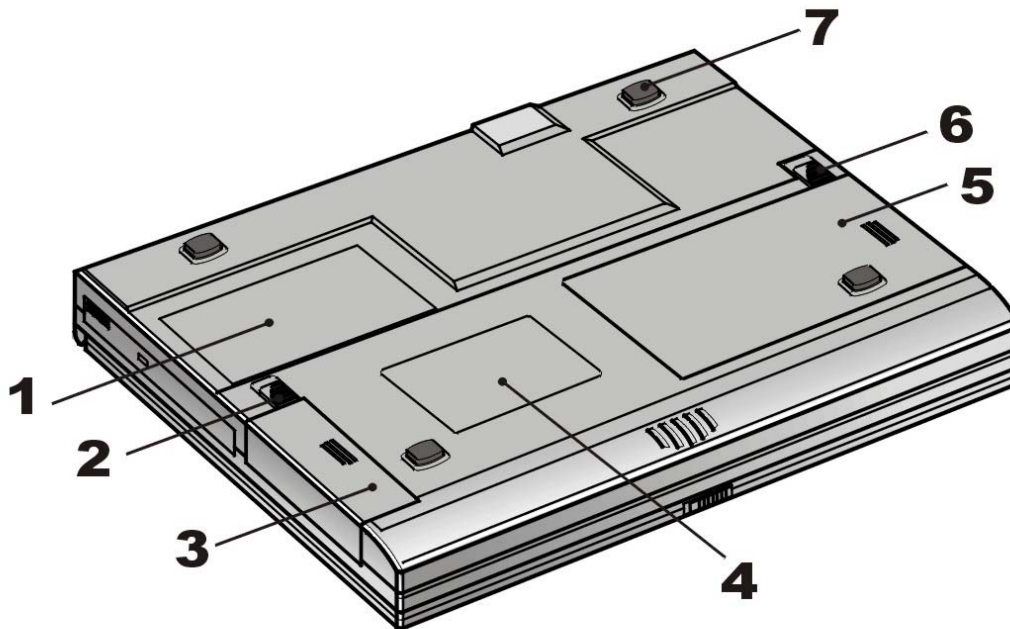

---

*Bottom View of 777S*

**1. RAM Cover**

**2. Battery Module Latch**

**3. Removable Battery Module**

777S comes equipped with a factory-installed battery pack module. After the battery is depleted, the module can be removed and replaced with a charged battery.

**4. FCC Label**

**5. Built-in FDD Module**

**6. FDD Module Latch**

**7. Rubber Stands**

The rubber feet are needed to elevate the computer allowing air to pass freely beneath the system. This will help ensure proper cooling of the computer.



## Chapter 2 Getting Started

## 2.1 Caring for the 777S

The 777S is a laptop system and requires careful handling. In order to avoid any damage, you have to observe the following precautions:

- Do not place heavy objects on top of system.
- Do not scratch or hit the surface of the display panel.
- Keep your 777S at least 13 cm (5 in) away from electrical appliances that generate strong magnetic fields, such as motors, televisions, refrigerators or powerful audio speakers.
- Do not disassemble the system yourself; unfamiliar operation will damage system.

## 2.2 The Power System

### 2.2.1 AC Power System

The power system for 777S is comprised of two parts, the power adapter and the battery power system. The power adapter converts AC power from a wall outlet to the DC power required by the computer. The battery pack consists of a set of Lithium-Ion (Li-Ion) battery cells housed together. The AC Adapter's primary function is to provide power to the computer that also charges the battery pack. When the power adapter is connected to the computer, it provides power to the computer and charges the internal battery at the same time as long as it is plugged into an electrical outlet.

 <b>Caution</b>	To protect your computer from damage, use only the power adaptor that came with this computer because each power adapter has its own power output rating.
---	---

### 2.2.2 Battery Power System

The 777S is designed to work with a removable battery pack located inside the battery pack compartment. A fully charged pack will provide several hours of battery life, which can be further extended by using power management features through the Solaris O.S. Additional battery packs (2<sup>nd</sup> Battery) are optional.

The internal battery is specially designed for use with your 777S. It incorporates a number of safety features.

- It is shaped to aid correct insertion.
- It contains electrical protection against damage by short circuit. It is physically protected against chemical leakage or rupture.

### 2.2.2.1 Battery Charging

---

The system will begin to charge battery when the AC adapter is attached whenever system is power on or not, the charge LED blinks in orange color to indicate that the battery is being charged, while the battery is fully charged, the LED will stop blinking.

The battery is charged at a faster rate until it is almost fully charged, and then the system automatically switches to a trickle charge to maintain the battery in good condition.



**Note** – A brand-new battery have to be fully charged. Before you start to enjoy the 777S, we strongly recommend to charges the battery at least 8 hours.

### 2.2.2.2 Battery Warning Beep

---

When your 777S run out of system battery, the battery low warning beep will be activated, the battery warning beep provides a visual warning when the battery is nearing exhaustion.

The battery warning beep provides three warning levels:

- First, the battery warning beep will be enabled when battery life reaches 20% of battery power remaining.
- Second, the battery warning beep will be enabled by each 3 seconds when battery life reaches 15% of battery power remaining.
- Third, 777S executes shutdown command automatically when battery life reaches 5% of battery power remaining.

At the second warning, you can take one of the following actions:

- Connect the AC adapter to charge the battery and continue working.
- Shutdown system, replace the battery with a fully charged battery and then power on system again.
- Save any files which you're currently working on and continue working before 777S performs an automatic shutdown.

### **2.2.2.3 Maximizing Battery Life**

---

The Battery life is around 2 hours at least; there are several ways for you to extend battery life, such as reducing the screen brightness when using battery power.

### **2.2.2.4 Operating On Internal Battery Power**

---

The internal battery typically powers your 777S for around 2 hours (or longer depending upon model and power saving options selected). Using any of the interfaces, particularly the Ethernet, or an external mouse or keyboard, causes a greater drain on the battery and may shorten this period.

### **2.2.2.5 Battery Behavior**

---

Your computer contains a sophisticated battery management system to ensure optimal performance from your batteries. However, for a new system or a system that has been in storage for an extended period of time, you should note the points below.

- **Self Discharge**

An inherent characteristic of the Li-ion internal battery supplied with your computer is *self-discharge*. This causes the battery to become exhausted after several weeks of storage even if it is not fitted into your computer. Also, when it is installed in your system, the internal battery will discharge while your computer is not in use. This may take up to 3 weeks depending on the level of charge when the system was last used.

- **System behavior with an Exhausted Battery**

The charge percentage may not be shown on the status display if the battery is completely exhausted. However, the percentage appears when the battery has been *characterized* by the battery management system after it has been fully charged.

---

### 2.2.2.6 Battery Conditioning

---

A brand-new battery, or one that has not been used for a long time, will store less charge than expected for the first few charge and discharge cycles. This is normal. Over the course of five charge and discharge cycles, the capacity of the battery will rise to its correct value.

## 2.3 Installing/Removing The Battery Pack

The 777S will come with its battery pack. Refer to the following procedures to install or remove the battery pack.

### 2.3.1 Installing The Battery Pack

---

1. Slide the battery pack into the battery bay.
2. Ensure the battery latch lock the battery completely.

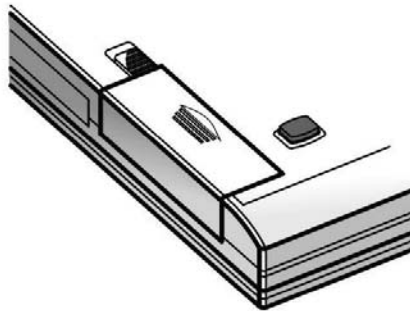

### 2.3.2 Removing The Battery Pack

---

1. Push and hold down the battery latch to unlock the battery pack.
2. Pull out the battery pack towards the arrow as figure below to remove the battery pack.

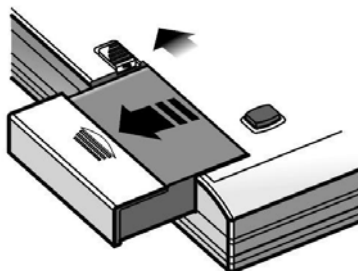



**Warning:** Do Not remove the battery pack while the computer is being use without the AC adapter.

## 2.4 Using the Power Adapter

The 777S comes with a universal AC-DC adapter, you can plug the power adapter into any AC outlet between 100 and 240 volts (50~60Hz) and it will automatically adjust without setting switches or using power converters. You can use it in just about any part of the world.

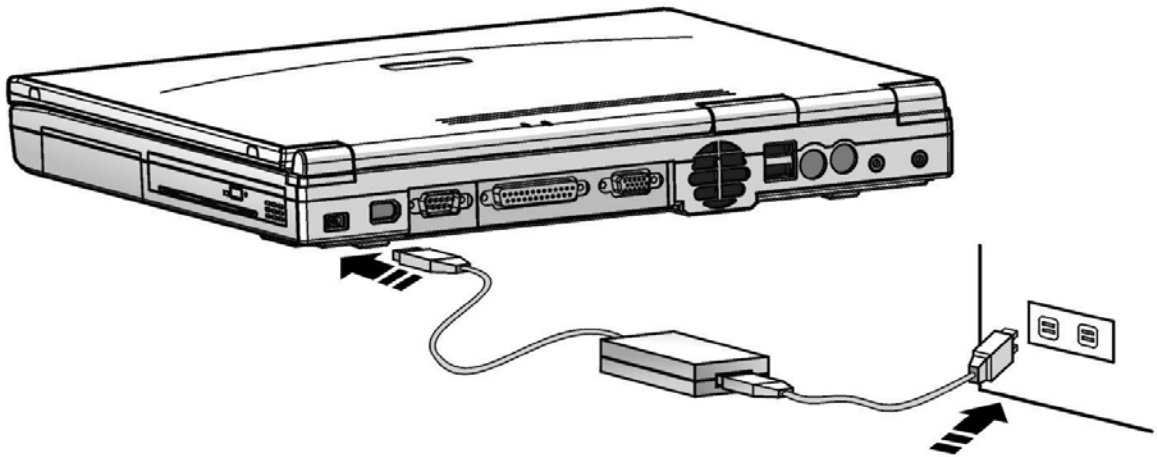

### 2.4.1 The AC Adapter

The most obvious way to conserve battery power is to avoid using the battery when there is an available AC power source. The AC Adapter is lightweight and compact, so it is very convenient to bring while traveling. By using the AC Adapter as much as possible, you can ensure that you will have a charged battery whenever you really need it.



Use only the power adapter that comes with your computer. **Do Not** use the adapter with any other electrical equipment.

Always plug the connector the AC outlet first to check whether the green LED light, that means the AC power is within accepted range, then connect the DC power to the DC-in jack of the computer.

## 2.5 Using and charging the battery

Use the factory-supplied AC adapter only to charge your battery. When the computer is connected to the AC adapter, the computer will recharge the battery. When AC adapter connected, the computer will use power from AC adaptor and the battery pack begins to charge no matter computer is being use or not. You do not have to worry about battery power as long as the Ac adapter is in use. And you do not have to worry about overcharging ether since a thermo sensor is built in the battery pack to prevent it.

The Li-Ion battery pack has no memory effect, but the discharging and recharging cycle is limited. After this time, the efficiency of battery may begin to decrease and you should consider purchasing a replacement from your dealer. Fully draining and charging the battery will last battery longer.



**Warning:** A brand-new battery should be fully charged before using. Always plug in the AC adapter to charge battery to keep your battery fully charged.

## 2.6 Powering ON your Computer

Push on the power button to turn on the computer. If the operating system locks up and cannot shutdown, press and hold the power switch for 4~5 seconds to force the computer to turn off.



**Warning**

**Do Not** turn off the computer while the hard drive or floppy is in use, doing this may loss or destruction your data. Always wait for 5 seconds after turning OFF your computer before turning it back ON.

## 2.7 The Power-On Self Test

When you power on the 777S, it will run through a diagnostic tests called Power-On Self Test (POST). The Power-On Self Test includes a record of the computer's configuration. It's used to make a hardware check of the system. In order to monitor the power on self-test, you have to connect a RS232 cable between your 777S and another computer through as ttya.

## 2.8 Power Management System Operation

The power management system allows to decreasing battery power dissipation. The power management program is provided by Solaris O.S. Click the right-button of touchpad and select "Power Manager" to display the "Dtpower" of power management application. The figure below will be displayed.

There are three power saving mode for choose:

- **Disabled**

No power saving

- **Minimal**

Display will be turned off after system idle for 30 minutes, Disk will always On

- **Standard**

Display and Disk will be turned off after system idle for 30 minutes  
You can click on the "More" icon and adjust your own power saving function.

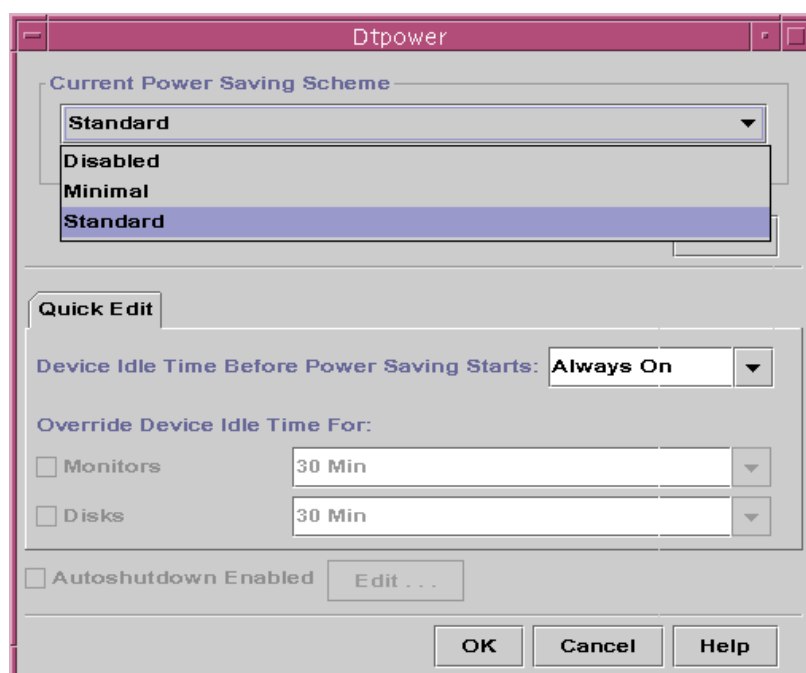

## Chapter 3 Using the Computer

## 3.1 Keyboard

The keyboard has an embedded numeric keypad on it. It is Solaris compatible and designed with inverted-T arrow keys for easy control of cursor movements.

You can also connect the system to an external Sun keyboard via the external USB port on the real panel.

### 3.1.1 Embedded Numeric Keypad

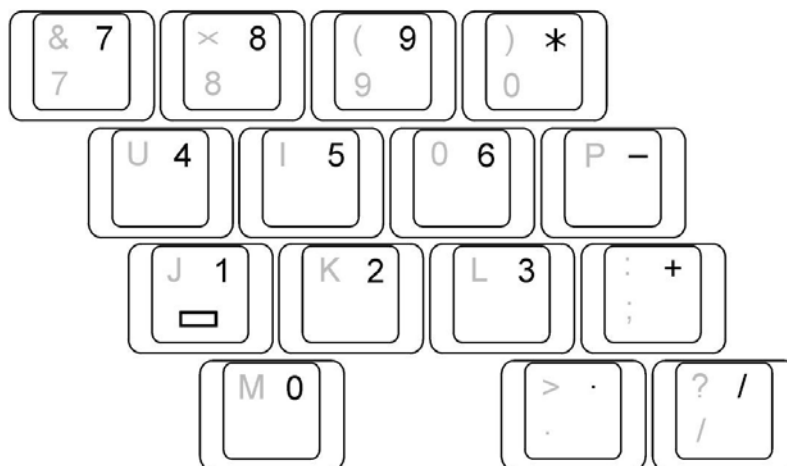

The embedded numeric keypad consists of 15 keys located central to the right side of the keyboard. It serves as a numeric keypad, cursor and screen-control, and as part of the normal keyboard.

The Num Lock  key is used to invoke the numeric keypad, the set of alphanumeric keys marked with blue numbers or characters on their front

face. By default, the Num Lock  indicator is off when you power on

your system. To turn on the Num Lock  indicator and activate the

embedded numeric keypad, press Fn  and Num Lock  keys.

If no external keyboard is attached, the function of this embedded numeric keypad will follow the status of the Num Lock key:

**Num Lock OFF:** The embedded numeric keypad acts as a normal keyboard and the Num Lock LED is turned off.

**Num Lock ON:** The embedded numeric keypad acts as a numeric keypad and the Num Lock LED is turned on.

When an external keyboard is attached to the system, the status of the Num Lock keys of the internal and external keyboard will track each other. That is, when the Num Lock of the internal keyboard is ON, the Num Lock of the external keyboard will also be on and vice versa. The function of the embedded numeric keypad and the external numeric keypad will still follow the status of the Num Lock key:

**Num Lock OFF:**

1. The embedded numeric keypad acts as a normal keyboard and the Num Lock LED is turned off.
2. The external numeric keypad acts as a cursor pad and the Num Lock LED of the external keyboard is turned off.

**Num Lock ON:**











1. The embedded numeric keypad acts as a numeric keypad and the Num Lock LED is turned ON.
2. The external numeric keypad acts as a numeric keypad and the Num Lock LED of the external keyboard is turned ON.

### 3.1.2 Hot Keys













The computer provides the followings Hot-Keys:













- For regular adjustment
- For Sun's Definition key

#### Regular adjustment for Audio and LCD brightness

		Disable/Enable System Sound Generation
		Increase Volume
		Decrease Volume
		Increase LCD Brightness
		Decrease LCD Brightness

#### Sun's Definition key

		Stop
		Props
		Compose
		Front
		Open
		Find
		Again

		Undo
		Copy
		Paste
		Cut
		Help
		Power Off

The keyboard has an embedded numeric keypad on it. It is Windows compatible and designed with inverted-T arrow keys for easy control of cursor movements.

You can also connect the system to a standard 101/102-key keyboard via the external keyboard jack on the real panel.

### 3.2 Pointing Device

The computer's integrated touchpad pointing device is fully compatible with all two-button mice. The touchpad is pressure sensitive and contains no moving parts; therefore, mechanical failures can be avoided.

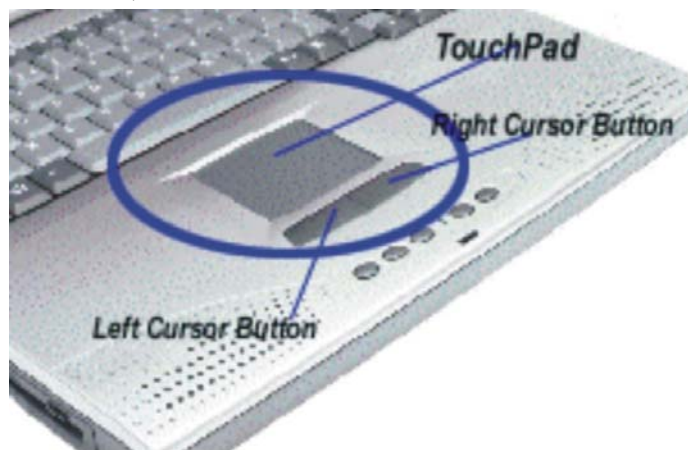

### 3.2.1 Using the Touchpad

Light pressure with the tip of your finger is all that is required to operate the touchpad. Because the touchpad is electrostatic sensitive, objects cannot be used in place of your fingers. The touchpad's primary function is to move the cursor around or select items displayed on the screen with the use of your fingertip. The following illustrations demonstrate proper use of the touchpad.

Moving the cursor – Place your finger in the center of the touchpad and do the following to move the cursor:

Up – Slide your finger forward

Left – Slide your finger to the left

Down – Slide your finger backward

Right – Slide your finger to the right

right

Clicking/Tapping – With the cursor over an item, press the left button or use your fingertip to touch the touchpad lightly, keeping your finger on the touchpad until the item is selected. The selected item will change color. The following 2 examples produce the same results.

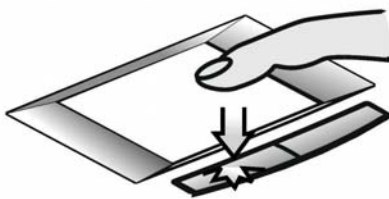

Clicking  
(Press the left cursor button  
and release)

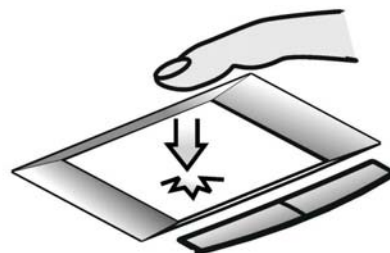

Tapping  
(Lightly but rapidly strike the  
touchpad)

Double-clicking/Double-tapping – This is a common skill for launching a program directly from the corresponding icon you select. Move the cursor over the icon you wish to execute, press the left button or tap the pad twice in rapid succession, and the system launches the corresponding program. If the interval between the clicks or taps is too long, the operation will not be executed.

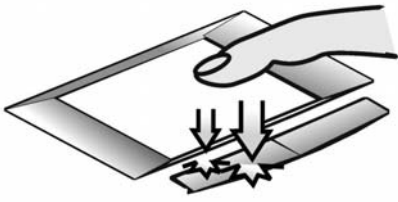

Double-Clicking  
(Press the left button twice  
and release)

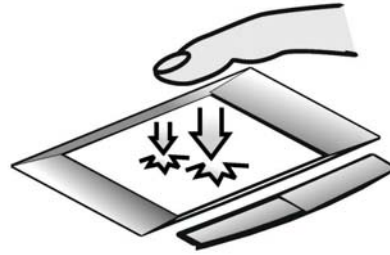

Double-Tapping  
(Lightly but rapidly strike the  
touchpad twice)

Dragging – Dragging means to pick up an item and place it anywhere on the screen you wish. You can move the cursor over the item you select, and while keeping the left button depressed, moving the cursor to the desired location, then release the button. Or, you can simply double-tap on the item and hold while dragging the item with your fingertip. The following 2 examples produce the same results.

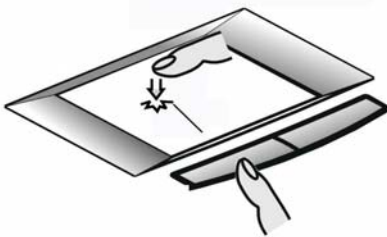

Dragging-Clicking  
(Hold left button and slide  
finger on touchpad)

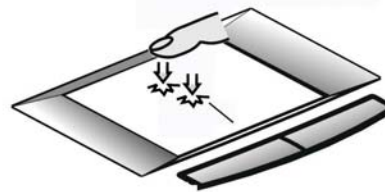

Dragging-Tapping  
(Lightly strike the touchpad  
twice and then slide)

### 3.2.2 Caring for the Touchpad

---

The touchpad is pressure sensitive. If not properly cared for, it can be easily damaged. Take note of the following precautions.

- Make sure the touchpad does not come into contact with dirt, liquids or grease.
- Do not touch the touchpad if your fingers are dirty or wet.
- Do not rest heavy objects on the touchpad or the touchpad buttons.
- Do not scratch the touchpad with your fingernails or any hard objects.



**NOTE:** The touchpad responds to movement not to force. There is no need to tap the surface too hard. Tapping too hard does not increase the responsiveness of the touchpad. The touchpad responds best to light pressure.

### 3.3 Mouse or Keyboard Connection

To allow easier cursor navigation or data entry, you may connect a USB mouse or keyboard to the USB ports on the rear of the 777S. Both ports follow standard USB specifications.

#### 3.3.1 Using An External Keyboard And Mouse

Although the built-in keyboard and mouse provide full functionality. If you are similar with the Sun keyboard, you can connect a use a USB Sun-compatible keyboard and mouse to the USB port on the rear system. The external keyboard and mouse interface is USB.



**Note** – Your 777S supports USB Sun-compatible type 6 keyboard and USB Sun-compatible mouse. Other types of mouse or keyboard may not be supported.



- The Sleep key on the USB keyboard behaves differently than the power key on Type-5 or Type-6 keyboards. On a USB keyboard, you can shutdown the system using the power key, but you cannot power-on the system.
- A regular USB keyboard may not support all function keys as the left block of Sun keyboard.
- Multiple keyboard/mouse are not supported. If connect a USB keyboard or USB mouse, you can only use the external USB keyboard/mouse. You cannot use internal and external keyboard/mouse simultaneous. **The priority for the external input device is higher than the internal input device.**
- The USB port do not support hot-plug, if you would like to use external USB keyboard/mouse, you must shutdown system, plug-in external keyboard/mouse than boot up system.
- The 777S only provides two-button Touchpad and do not support three-button. We recommended you to connect a three-button external USB mouse to use the third-button function in the Solaris environment.
- Reboot your system after you plug-in external USB Sun-compatible type 6 keyboard/mouse.

### 3.4 External Display Connections

Connecting an external CRT monitor or Projector is just like on a standard desktop PC. Just plug-in the VGA cable and ready to use.

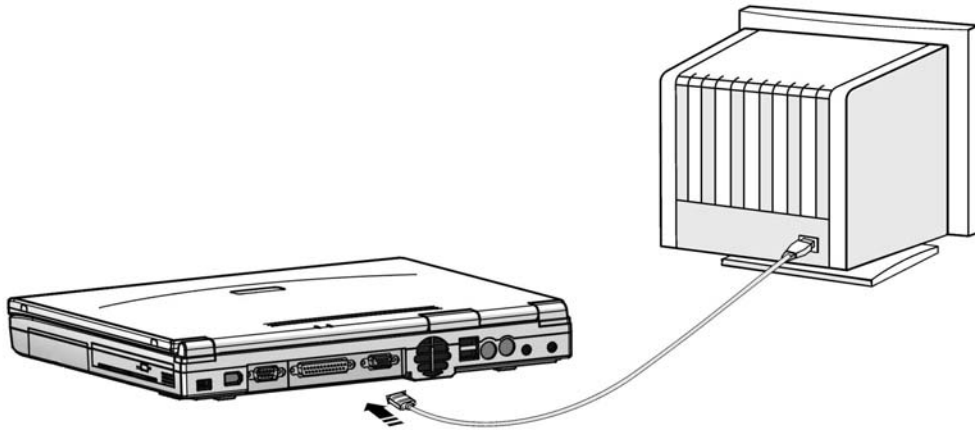

### 3.5 External Audio Connections

The 777S provides easy access for connecting a stereo headphone, mono microphone, and a stereo audio source just like on some personal tape recorders.

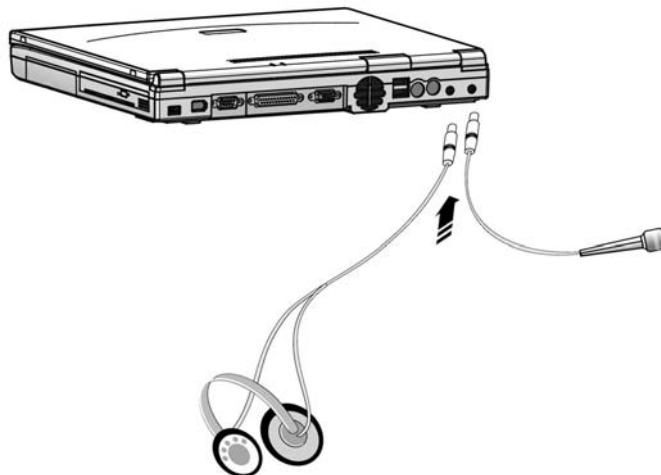

### 3.5.1 Adjust Mic-In and Line-out

The Audiotool in the OpenWindows environment allows you to record and play back audio files and provides controls to adjust the input level of the microphone, Mic-In and the volume of the speaker and Line Out.

For more information about Audiotool, please refer to your Solaris™ documentation.

### 3.5.2 Using The Build-in Stereo Speaker

The built-in stereo speaker provides an audio output of limited quality, suitable for voice or telephony applications. These can be used with Audiotool or with other voice-based applications.

#audiotool

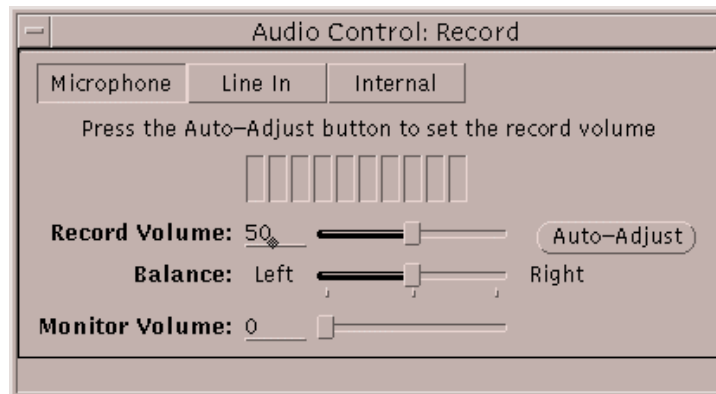
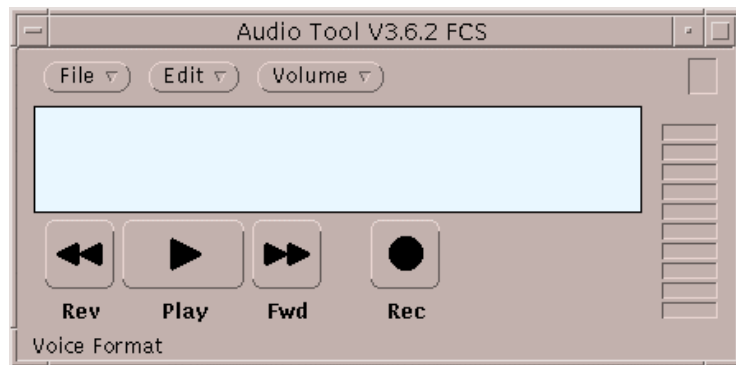

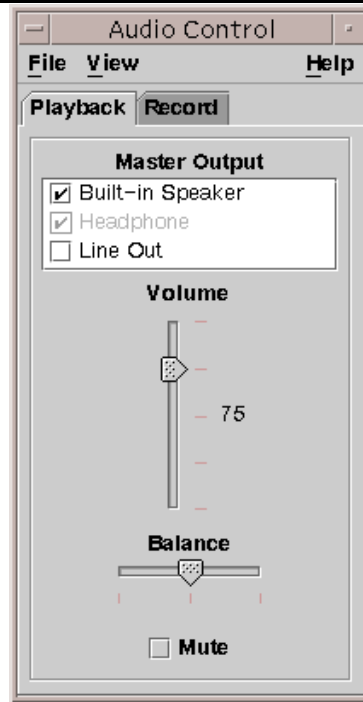

### 3.5.3 External Audio Outputs

The Line Out provides a suitable input for a PA amplifier or for active or multimedia speakers (speakers that contain their own amplifier). The audio output can be adjusted to provide CD-quality sound reproduction.

## 3.6 Network Connections

The built-in network comes with both an RJ-45 port. RJ-45 network cables are found connecting network computers to network hubs or switches usually found in business environments.

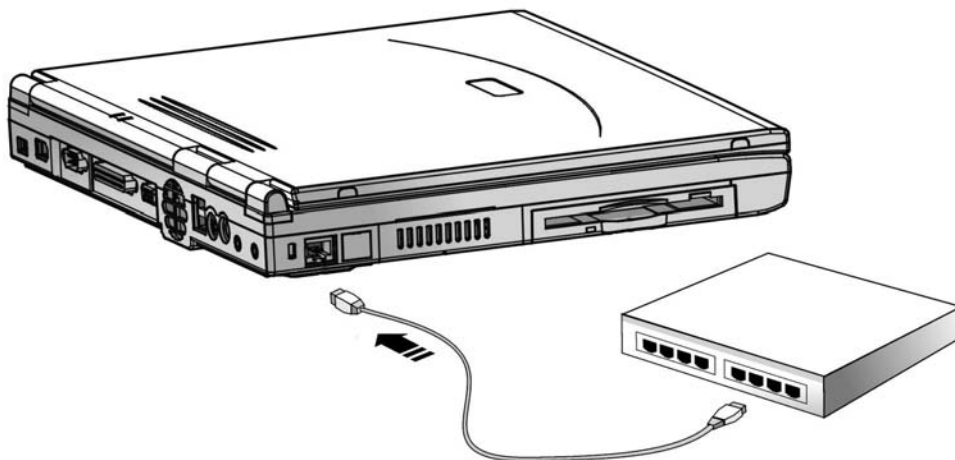

---

### 3.6.1 Network Connection

---

Connect a network cable, with RJ-45 connectors on each end, to the network port on the 777S and the other end to a hub or switch. For 100BASE-TX speeds, your network cable must be category 5 (not category 3) with twisted-pair wiring. If you plan on running the interface at 100Mbps, it must be connected to a 100BASE-TX hub (not a 100BASE-T4 hub). For 10Base-T, use category 3,4, or 5 twisted-pairing wiring. Duplex transfers (up to 200Mbps) are supported on 777S but requires connection to a switch with "duplex" enabled.

### 3.7 System Memory Expansion

Under some circumstances, you may find additional memory is required. This is particularly true as applications become more complex. Expanding system memory is one method of increasing system performance by decreasing hard disk access. Two non-standard 144-pin SO-DIMM (Small Outline Dual Inline Memory Module) sockets are available for system memory expansion using manufacturer's SDRAM SO-DIMM modules. Currently, SO-DIMM memory sizes are available in 256MB and 512MB for each module. The maximum memory size you can expand the 777S to is 1GB using two 512MB SO-DIMMs. The 777S automatically detects the amount of memory in the system and configure OBP accordingly during the POST (Power-On-Self-Test) process. There is no hardware or software setup required after the memory is installed. Only purchase expansion modules from your authorized retailer to ensure compatibility and reliability. The memory module has to be installed by a certified technician.

### 3.8 Securing Your Computer

A third party lock such as the ones by Kensington can be used to secure your 777S physically to an unmovable object. The cable wraps around an object and the "T" shaped end inserts into the Kensington lock port as shown in this illustration and a key or combination dial is used to secure the lock in place.

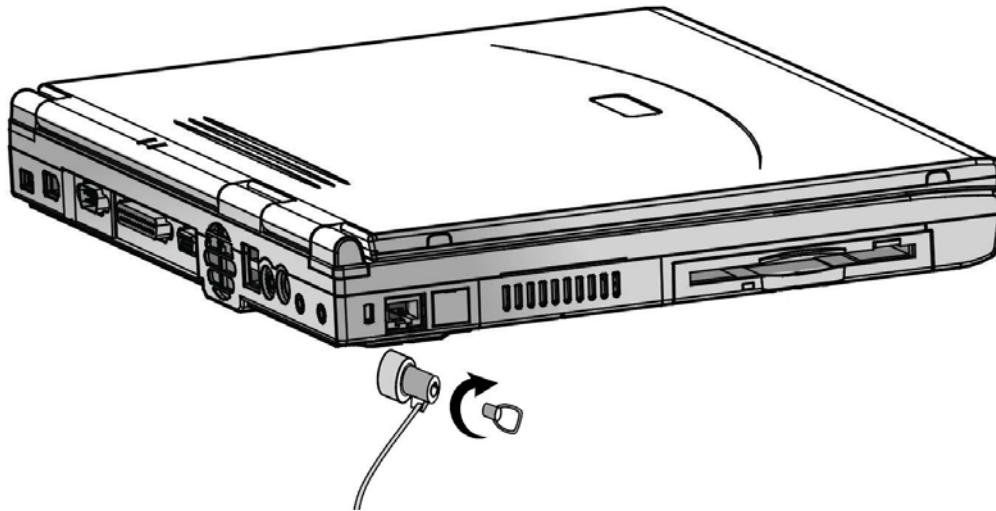





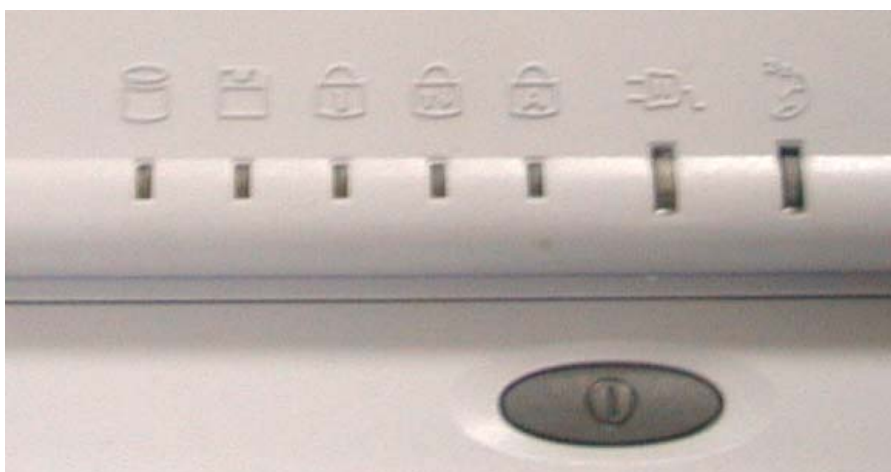

### 3.9 LED Indicators

There are seven LED indicators to provide current operating status information. Upon activating a certain function, a LED corresponding to that function will blink until you deactivate that feature.

Refer to the following figure to find the location of the LED indicators.



A description for each LED is listed below.

<p><b>Standby</b></p>		<p>This LED is currently not defined.</p>
<p><b>Power And Charge Indicator</b></p>		<ul style="list-style-type: none"> <li>• The LED blinks in green color to indicate the AC adapter is plugged-in; the system is powered ON and using power from AC adapter.</li> <li>• The LED blinks in orange color to indicate the computer is using battery power.</li> <li>• The LED start blinking in orange color to indicate the computer is charging the battery, the LED will stop blinking if battery is fully charged.</li> </ul>
<p><b>Caps Lock</b></p>		<p>LED blinks to indicate the caps lock feature is engaged. Press the [Caps Lock] key again to deactivate this feature.</p>
<p><b>Scroll Lock</b></p>		<p>LED blinks to indicate the scroll lock is engaged. Press the [Scroll Lock] key again to deactivate this feature.</p>
<p><b>Num Lock</b></p>		<p>LED blinks to indicate the embedded keypad's numeric feature is activated. Press the [Num Lock] key again to deactivate this feature.</p>
<p><b>FDD Activity</b></p>		<p>LED blinks to indicate the floppy is activated. System is accessing the floppy diskette from the floppy. The LED will always blink if you remove floppy and swap to 2nd battery.</p>
<p><b>HDD Activity</b></p>		<p>LED blinks to indicate the hard disk or DVDROM drive is activated. System is accessing the hard drive or DVD-ROM.</p>

## 3.10 Using Serial Devices

You can connect a variety of serial devices to your 777S via either of the serial port located on the rear I/O panel, such as terminals, modems and scanners.

### 3.10.1 Configuring Serial Connections

To configure a serial port for a terminal or modem in the OpenWindows or CDE desktops, login as root and use admintool as follows:

1. Launch admintool from within a cmdtool window with the following command:  
# admintool
2. From the Browse menu, select Serial Ports. The Serial Ports menu is displayed:

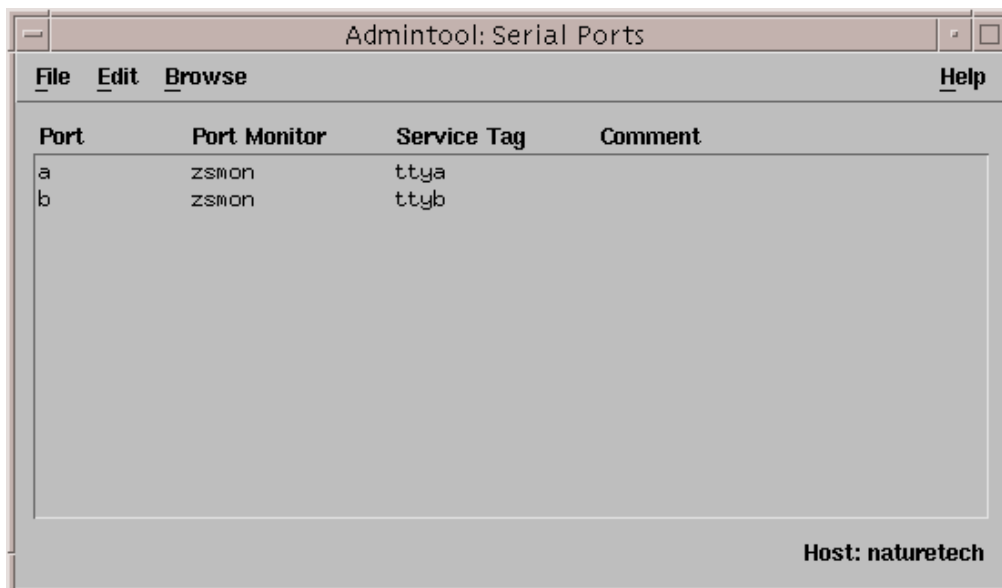

Ports a&b are the serial ports on the I/O panel of your 777S that are configured by default for terminal connection.

3. To edit a port's configuration, double-click the associated entry's line. A Modify Serial Port window is displayed.
4. Use this window to edit the parameters, such as baud rate and terminal type, for the port to suit your external device and application and then click on Apply to save the changes. You will need to consult the documentation for your serial device for information about the serial interface requirements.

For further more detailed manual to configuring serial devices, see the Sun Solaris™ documentation.

## 3.11 Using Parallel Devices

You can connect a range of devices to the parallel port on the rear of 777S, including printers and scanners. The parallel port provides a 25-pin D-type connector.

### 3.11.1 Configuring Parallel Devices

---

For information about configuring parallel devices, refer to your Sun Solaris™ documentation.

## Chapter 4 Security System

This chapter describes the security system for 777S. There are three security levels to secure your data. The security system contains hardware, firmware and software security.

## 4.1 Personal ID Security



The personal ID security is a unique, self-contained digital signature ciphering security/tracking device. A simple and intuitive 4-button keypad interface allows for over 800K password possibilities with any combination up to 5 buttonstrokes. The personal ID security requires no software intervention, rendering the locking mechanism relatively hacker-proof. The personal ID security function is designed for secure your data, preventing unauthorized access to the system.

We provide purely hardware operation. When the security password being created, you can't "Power On" your computer without password.

### Entering the User Password

Holds down button 1 and the enter button together for more than 5 seconds takes the personal ID security to user password input mode. Upon entering the beginning of any password input mode, LED will start blinking until enter button is pressed. There are 4 dedicated security buttons to the personal ID security, and a password up to 5 buttonstrokes can be entered. Multiple buttons can be entered together as one single buttonstoke. To complete the password keying process, press the enter button. After entering the password, the personal ID security will enter to security mode when the system is powered off and restarted.

### Password Erasure and Modification

The password can be erased if they are no longer needed. A new password can be entered only if the old one is erased. Holds down button 3 and the enter button together for more than 5 seconds to enter the erasing user password mode, after key in the user password and enter button, user password will be erased. A new user password can be entered if desired.

Upon entering any erasing or entering mode, LED will start blinking (ESCAPE timer will start as well) until enter button is pressed. If wrong password is entered, LED will start blinking in Red color. Whenever any button entering sequence is started, ESCAPE timer starts to count. ESCAPE timer can be reset by any button is pressed. For any reason the user can not finish the entering sequence before ESCAPE timer is expired, security mode will go back to previous state. In entering or erasing password mode, security mode will terminate the sequence, then goes back to previous state.

#### 4.1.1 Operation instruction

##### 4.1.1.1 Create password:

---

1. Power on system
2. Hold down button 1 and enter button together for more than 5 seconds for creating User Password, LED will start blinking until enter button is pressed.
3. Press button #1~4 to enter your password, then press “**Enter**” key to create password.

##### 4.1.1.2 Erase password:

---

1. Power on system and enter your password.
2. Hold down button 3 and the enter button together for more than 5 seconds for erasing User Password, LED will start blinking until enter button is pressed.
3. Press button #1~4 to enter your password, then press “**Enter**” key to erase password.



1. **If you do not set security password, you can power on system by press power button and boot up your system directly.**
2. **After password is created, when the system is on, the LED will blink with Green color, system will enter security mode as long as a valid password is found, you have to enter the correct password and Enter button to boot up your system.**
3. **If you fail to enter the correct password 3 times continually, the LED will blink with Red color and system is remaining**

locked. When the Red LED blink, password enter is still possible, if you press the correct password, system will boot up and LED will be turned off.

4. If you press the power button and do not press password for 30 seconds, the LED will turn off. You have to remove any power source (AC Adaptor & Battery) for about 1 minute then plug-in power source; press power button again and press correct password to boot up your system.
5. Please keep your password in your mind and don't forget the password.
6. Please don't forget to press the Enter key when you create/erase your password, if you do not press Enter key, system will not take any affect.
7. If you forget your Supervisor password, unfortunately, you have to replace the motherboard or send back your system to repair.

#### 4.1.2 Key combination

This security function allows you to protect your personal notebook's information than ever. We provide this function with multiple degrees to setup password. At most, there are five degrees. That means you can set single key or combination keys for every degree. Refer to the picture below to reference.

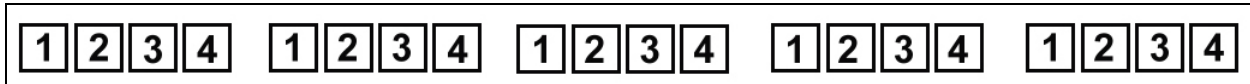

##### 4.1.2.1 Single Key

The password allows to created as single key, it could be one key, two keys, three keys, four keys or five keys. For this example, you can just push on key#1 then push on **Enter** key, or "1", "2" or "1" "2" "3" or "1" "2" "3" "4" "1" then push on **Enter** to create password.

### 4.1.2.2 Combination Key

You can set your password with combination key for every degree. For example, you can push on “1+2”, “2+3”, “3+4”, “1+3”, “2+4” then push on **Enter** key or “1” “1+2” “1+2+3” “1+2+3+4” “1+2” or any possible combination password you like to create.

You can also create password such as “1+2” or “1+2+3” or “1+2+3+4” then push on “**Enter**” to create your own password.



**You must create your password very carefully, we recommend you try to press these buttons before you set the password. If you set your password as combination key, you have to press these keys simultaneous for every degree. Please consider whether your fingers can fit in with the space for the buttons and whether you can press your combination key simultaneous. Otherwise, maybe you can set your own password but you can't press them simultaneous when you shutdown system and try to power on your system.**

## 4.2 Firmware Security (OBP)

### 4.2.1 Security Mode Commands

<b>full</b>	All commands except for “go” require the password.
<b>command</b>	All commands except for “boot” and “go” require the password.
<b>none</b>	No password required (OBP default Setting).

#### 4.2.1.1 Command Security

With security-mode set to command:

- A password is not required if you type the boot command by itself. However, if you use the boot command *with an argument*, a password is required.
- The go command never asks for a password.
- A password is required to execute any other command.

Examples are shown in the following screen.

```
ok
boot (no password required)
ok go (no password required)
ok boot filename (password required)
Password: (password is not echoed as it is typed)
ok reset-all (password required)
Password: (password is not echoed as it is typed)
```

**Caution**

It is important to remember your security password and to set the security password *before* setting the security mode. If you forget this password, you cannot use your system; you must call your vendor's customer support service to make your machine bootable again.

To set the security password and command security mode, type the following at the

```
ok prompt:
ok password
ok New password (only first 8 chars are used):
ok Retype new password:
ok setenv security-mode command
ok
```

The security password you assign must be between zero and eight characters. Any characters after the eighth are ignored. You do not have to reset the system; the security feature takes effect as soon as you type the command.

If you enter an incorrect security password, there will be a delay of about 10 seconds before the next boot prompt appears.

---

### 4.2.1.2 Full Security

---

The full security mode is the most restrictive. With security-mode set to full:

- A password is required any time you execute the boot command.
- The go command never asks for a password.
- A password is required to execute any other command.

Here are some examples.

```
ok go (no password required)
ok boot (password required)
Password: (password is not echoed as it is typed)
ok boot filename (password required)
Password: (password is not echoed as it is typed)
ok reset-all (password required)
Password: (password is not echoed as it is typed)
```

To set the security password and full security, type the following at the ok prompt:

```
ok password
ok New password (only first 8 chars are used):
ok Retype new password:
ok setenv security-mode full
ok
```

## 4.3 Software Security (Solaris)

---

### 4.3.1 Setting Superuser Password

---

Each 777S must create superuser password at the first start, Solaris will bring system to Initial System Configuration, the last step will need to enter superuser (root) password as below. Follow the on-screen instruction to create your superuser (root) password.

On this screen you can create a root password.

A root password can contain any number of characters, but only the first eight characters in the password are significant. (For example, if you create `a1b2c3d4e5f6` as your root password, you can use `a1b2c3d4` to gain root access.)

You will be prompted to type the root password twice; for security, the password will not be displayed on the screen as you type it.

> If you do not want a root password, press RETURN twice.

Root password:

Re-enter your root password.

Press Return to continue.

System identification is completed.

rebooting system due to change(s) in /etc/default/init

Jul 30 17:19:32 rpcbind: rpcbind terminating on signal.

syncing file systems... done

rebooting...

Resetting ...



- Superuser passwords must be kept secret and known only to administrator. Each user account should be assigned a password, which is a combination of six to eight letters, numbers, or special characters. You can set a user's password when you create the user account and have the user change it when logging in to a system for the first time.
- To make your computer systems more secure, ask users to change their passwords periodically. For a high level of security, you should require users to change their passwords every six weeks. Once every three months is adequate for lower levels of security. **System administration logins (such as root and sys) should be changed monthly, or whenever a person who knows the root password leaves the company or is reassigned.**

### 4.3.2 How to change Password

In order to change superuser password, you have to become a superuser (root) then you can change superuser password.

- **Become superuser by one of the following methods. Both methods require that you know the root password.**

1. Change to the superuser account by using the su command.

```
% su
Password: root_password
#
```

2. Log in as superuser on the system console.

```
hostname console: root
Password: root_password
#
```

The pound sign (#) is the Bourne shell prompt for the superuser account.

- **Change superuser (root) password by “passwd” command**

```
#passwd
passwd: Changing password for root
New password: (Enter new password)
Re-enter new password: (Enter new password again)
Passwd (SYSTEM): passwd successfully changed for root
#
```



New superuser (root) will be valid if you logged out Solaris. You must logged out Solaris activate new superuser password.

### 4.3.3 Administer Passwords

You can use Admintool for password administration, which includes specifying a normal password for a user account, enabling users to create their own passwords during their first login, disabling or locking a user account, or specifying expiration dates and password aging information.

Admintool can only be use in the CDE session. Follow the instruction to use "Admintool":

1. Log in Solaris as root and enter superuser (root) password. Log in the CDE session.
2. Push on the right mouse button and select "**Tools**" then select "**Admintool**". The picture below will appear.

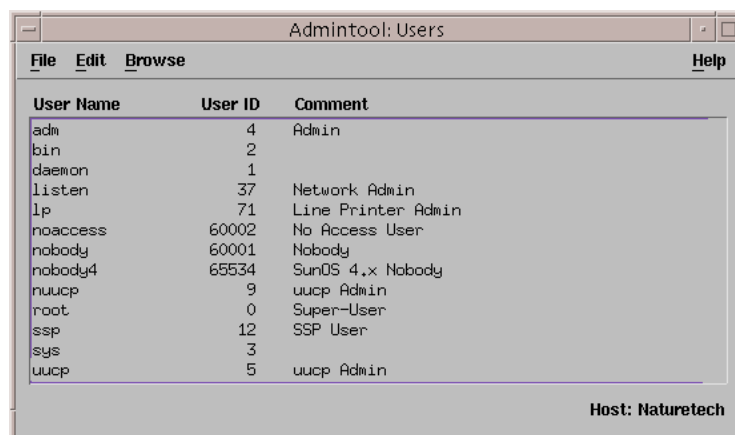

3. Click on the "Browse" item and select "**Users**", click on the "**Edit**" item then select "**Add**", the task as picture below will appear. In order to manage the user account group, you can refer to "**system administration guide**", the document could be found at: [docs.sun.com](http://docs.sun.com)

Admintool: Add User

**USER IDENTITY**

User Name:

User ID:

Primary Group:

Secondary Groups:

Comment:

Login Shell:  /bin/sh

**ACCOUNT SECURITY**

Password:

Min Change:  days

Max Change:  days

Max Inactive:  days

Expiration Date:

(dd/mm/yy)

Warning:  days

**HOME DIRECTORY**

Create Home Dir:

Path:

OK Apply Reset Cancel Help



Many breaches of computer security involve guessing a legitimate user's password. You should make sure that users avoid using proper nouns, names, login names, and other passwords that a person might guess just by knowing something about the user.

Good choices for passwords include:

- Phrases
- Nonsense words made up of the first letters of every word in a phrase
- Words with numbers or symbols substituted for letters (b00k for book)

Do not use these choices for passwords:

- Your name, forwards, backwards, or jumbled
- Names of family members or pets
- Car license numbers
- Telephone numbers
- Social Security numbers
- Employee numbers
- Names related to a hobby or interest
- Seasonal themes, such as Santa in December Any word in the dictionary



## Chapter 5 Initial System Configuration

This chapter describes general information about the initial system configuration of your 777S.

The Solaris O.S will Pre-installed to the hard drive for the 777S. AT the first time you boot up system, it will bring you to the initial system configuration setup screen. Setting all user configuration for your 777S. After you finish the system configuration, you may start to using 777S in the Solaris O.S. This chapter will guide you to configure your 777S by step-by-step instruction.

## 5.1 Overview of System Configuration

Before you configure your 777S, you have to prepare some information for the system configuration. You may need some help from your system administrator. You need to provides information as following:

- Assigning a host name and obtain a Internet Protocol (IP) address
- Set your own time zone
- Set a password for the superuser (root) account
- Create user accounts
- Network configuration information

## 5.2 Initial Configuration

Before you configure your system, you have to collect information as the table below. You may need to consult your system administrator to obtain needed information.

Category	Example	Your Configuration
Host Name	xxxxx	
IP Address	192.168.1.10	
Subnet Mask	255.255.255.0	
Name Service	DNS	
Domain Name	naturetech.com.tw	
DNS IP Address	192.168.1.1	
Time Zone	No example given	
User Name	xxxxx	

### 5.2.1 Select Locale

The first screen will display as below at the first time you boot up system. Select your own locale in the following then press "F2" key to next step. In the configuration procedure, you should always press "F2" to continue setup process.

Select a Locale

0. English (C - 7-bit ASCII)
1. Albania (ISO8859-2)
2. Australia (ISO8859-1)
3. Belgium-Flemish (ISO8859-1)
4. Belgium-Flemish (ISO8859-15 - Euro)
5. Bosnia (ISO8859-2)
6. Brazil (ISO8859-1)
7. Bulgaria (ISO8859-5)
8. Canada-English (ISO8859-1)
9. Catalan, Spain (ISO8859-1)
10. Catalan, Spain (ISO8859-15 - Euro)
11. Croatia (ISO8859-2)
12. Czech Republic (ISO8859-2)
13. Denmark (ISO8859-1)
14. Denmark (ISO8859-15 - Euro)
15. Egypt (ISO8859-8)
16. Estonia (ISO8859-15)
17. Finland (ISO8859-1)
18. Finland (ISO8859-15 - Euro)

Press Return to show more choices.

Please make a choice (0 - 51), or press h or? for help:

After selecting locale, system will bring to network configuration settings process. You may need some assistant from your system administrator.

### 5.2.2 Configure network settings

#### - Network Connectivity

Specify Yes if the system is connected to the network by one of the Solaris or vendor network/communication Ethernet cards that are supported on the Solaris CD. See your hardware documentation for the current list of supported cards.

Specify No if the system is connected to a network/communication card that is not supported on the Solaris CD, and follow the instructions listed under Help.

Networked

Yes

No

F2\_Continue      F6\_Help

#### - DHCP

On this screen you must specify whether or not this system should use DHCP for network interface configuration. Choose Yes if DHCP is to be used, or No if the interfaces are to be configured manually.

WARNING: Because this machine booted from the network, DHCP support will not be enabled, if selected, until after the system reboots.

Use DHCP

Yes

No

F2\_Continue      F6\_Help

### 5.2.3 Network Information

---

Assign the Host Name for your 777S.

- Host Name

---

-----  
On this screen you must enter your host name, which identifies this system on the network. The name must be unique within your domain; creating a duplicate host name will cause problems on the network after you install Solaris.

A host name must be at least two characters; it can contain letters, digits, and minus signs (-).

Host name: simon

---

-----  
F2\_Continue      F6\_Help

### 5.2.4 Internet Address

---

Assign the IP address your 777S.

The IP address must be unique for your system.

- IP Address

---

-----  
On this screen you must enter the Internet Protocol (IP) address for this system. It must be unique and follow your site's address conventions, or a system/network failure could result.

IP addresses contain four sets of numbers separated by periods (for example 129.200.9.1).

IP address: 192.168.1.10

---

-----  
F2\_Continue      F6\_Help

## 5.2.5 Subnets

This screen prompts you to specify whether your system is going to be a part of a subnet. Larger corporate networks are often divided into smaller segments called subnets. If your system is a standalone system, enter No. If your system would be connected to a large network, you will need to consult your system administrator to obtain information for subnet settings.

- Subnets
-----
-----
On this screen you must specify whether this system is part of a subnet. If you specify incorrectly, the system will have problems communicating on the network after you reboot.
> To make a selection, use the arrow keys to highlight the option and press Return to mark it [X].
System part of a subnet
-----
[X] Yes
[ ] No
-----
-----
F2_Continue      F6_Help

- IPv6

---

On this screen you should specify whether or not IPv6, the next generation Internet Protocol, would be enabled on this machine. Enabling IPv6 will have no effect if this machine is not on a network that provides IPv6 service. IPv4 service will not be affected if IPv6 is enabled.

> To make a selection, use the arrow keys to highlight the option and press Return to mark it [X].

Enable IPv6

---

- [ ] Yes
  - [X] No
- 

F2\_Continue      F6\_Help

## 5.2.6 Name Service

The following step needs to select name service mode. Consult your system administrator to obtain information for name service settings.

```
- Name Service
-----
---
On this screen you must provide name service information. Select the
name service that will be used by this system, or None if your system will
either not use a name service at all, or if it will use a name service not
listes here.
>To mark a selection, use the arrow keys to highlight the option and
press Return to mark it [X].

Name service
-----
[ ] NIS+
[ ] NIS
[X] DNS
[ ] LDAP
[ ] None
-----
-----
F2_Continue    F6_Help
```

```
- Domain Name
-----
-
On this screen you must specify the domain where this system resides.
Make sure you enter the name correctly including capitalization and
punctuation.

Domain name: naturetech.com.tw
-----
-----
F2_Continue    F6_Help
```

- DNS Server Addresses

---

On this screen you must enter the IP address of your DNS server(s). You must enter at least one address. IP addresses must contain four sets of numbers separated by periods (for example 129.200.9.1)

Server's IP address: 192.168.1.1

Server's IP address:

Server's IP address:

---

F2\_Continue      F6\_Help

- DNS Search List

---

On this screen you can enter a list of domains that will be searched when a DNS query is made. If you do not enter any domain, DNS will only search the DNS domain chosen for this system. The domains entered, when concatenated, may not be longer than 250 characters.

Search domain: naturetech.com.tw

Search domain:

Search domain:

Search domain:

Search domain:

Search domain:

---

F2\_Continue      F6\_Help

- Confirm Information

---

>Confirm the following information. If it is correct, press F2; to change any information, press F4.

Name service : DNS

Domain name: naturetech.com.tw

Server address(es): 192.168.1.1

Search domain(s): naturetech.com.tw

---

F2\_Continue      F6\_Help

## 5.2.7 Time Zone

Select your own Time Zone. If your time zone does not correspond with any of those listed, you can set a time zone relative to Greenwich Mean Time (GMT), also known as Coordinated Universal Time (CUT), or specify a time zone file to be used.

- Time Zone

-----  
-----  
On this screen you must specify your default time zone. You can specify a time zone in three ways: select one of the geographic regions from the list, select other - offset from GMT, or other - specify time zone file.

> To make a selection, use the arrow keys to highlight the option and press Return to mark it [X].

Regions

- 
- Africa
  - Asia, Eastern
  - Asia, Western
  - Australia / New Zealand
  - Canada
  - Europe
  - Mexico
  - South America
  - United States
  - other - offset from GMT
  - other - specify time zone file
- 

-----  
F2\_Continue      F6\_Help

---

- Time Zone

---

-----  
> To make a selection, use the arrow keys to highlight the option and press Return to mark it [X].

Time zones

- [X] Eastern  
[ ] Central  
[ ] Mountain  
[ ] Pacific  
[ ] East-Indiana  
[ ] Arizona  
[ ] Michigan  
[ ] Samoa  
[ ] Alaska  
[ ] Aleutian  
[ ] Hawaii
- 

-----  
F2\_Continue      F5\_Cancel      F6\_Help

---

### 5.2.8 Date and Time settings

---

- Date and Time

---

---  
> Accept the default date and time or enter new values.

Date and time: 2001-07-30 20:18

Year (4 digits) : 2001  
Month (1-12) : 07  
Day (1-31) : 30  
Hour (0-23) : 20  
Minute (0-59) : 18

---

-----  
F2\_Continue      F6\_Help

```
- Confirm Information
-----
> Confirm the following information.  If it is correct, press F2; to change
any information, press F4.

    Time zone: US/Eastern
    Date and time: 2001-07-30 20:18:00
-----
-----
F2_Continue    F4_Change    F6_Help
```

### 5.2.9 Setting A Superuser (root) Password

Enter a password for the superuser (root) account. The superuser account has special privileges and is used mainly for system administration tasks. Inadvertent or unauthorized use of some of the commands available to super user can damage the operating system and render your 777S unusable. For this reason you are advised to set a password for the superuser account.

The password should consist of a minimum of six characters. Any printable characters can be used including letters, numbers and punctuation marks.

After you have entered your root password, a Solaris™ operating system displays the Solaris™ login prompt. You should create a user account as described in the next section.

On this screen you can create a root password.  
A root password can contain any number of characters, but only the first eight characters in the password are significant. (For example, if you create `a1b2c3d4e5f6` as your root password, you can use `a1b2c3d4` to gain root access.)  
You will be prompted to type the root password twice; for security, the password will not be displayed on the screen as you type it.

> If you do not want a root password, press RETURN twice.  
Root password:  
Re-enter your root password.  
Press Return to continue.  
System identification is completed.

rebooting system due to change(s) in /etc/default/init  
Jul 30 17:19:32 rpcbind: rpcbind terminating on signal.  
syncing file systems... done  
rebooting...  
Resetting ...



- Many of the operations described in this manual require you to be logged in as root. The root account gives you the privileges required to carry out system administration tasks such as disk maintenance. However, using the root account for day-to-day purposes is very risky as you can easily cause damage to the operating system.
- As a rule, you should log in to your normal user account for every day purposes. Then, when you need to carry out particular task as root, enter the su command and the root password to log in to the root account:  
% su  
Password:  
#
- The hash prompt (#) indicates that you have root privileges. When you have completed the task requiring root privilege, close the root account by pressing Ctrl-D on the keyboard.

## 5.3 Create a User Account

### Starting the User Account Manager

For daily use, you should set up a user account by using "Admintool" in the CDE environment. This provides an easy-to-use way to create a user account. To open an admintool window carry out the following steps:

1. At the Solaris™ login window, log in as root and then the CDE desktop is displayed.
2. Move the cursor to a clear area of the desktop background and press right mouse button. The CDE desktop Workspace menu is displayed.
3. From the Workspace menu, select Tools and then AdminTool. The Admintool window is displayed. If necessary, select the User from the Browse menu to display a list of users.
4. From the Edit menu, select Add. The Add User window is displayed.

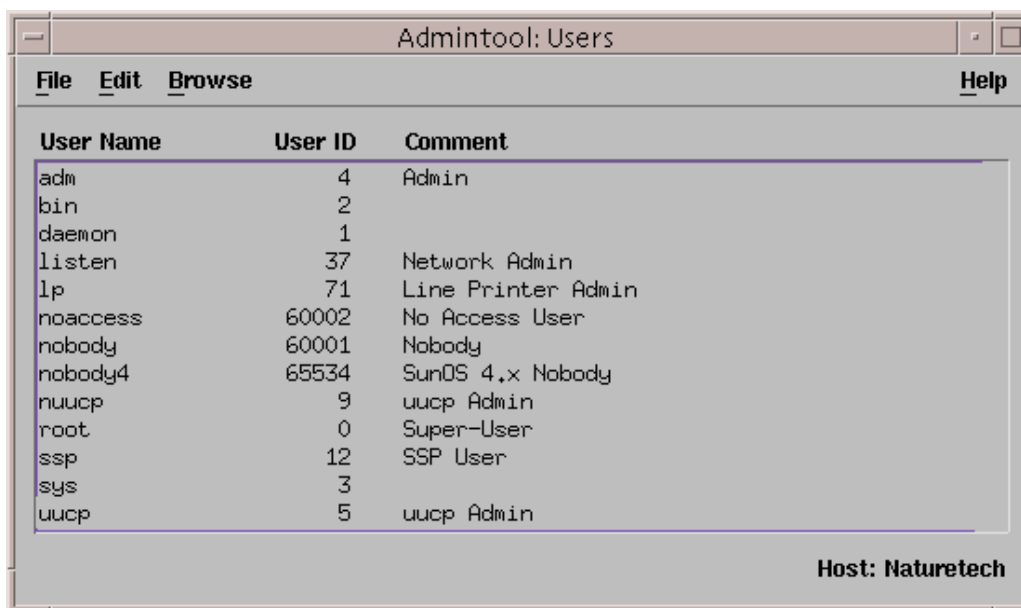

The screenshot shows a window titled "Admintool: Users" with a menu bar containing "File", "Edit", "Browse", and "Help". The main area displays a table of system users with the following columns: "User Name", "User ID", and "Comment".

User Name	User ID	Comment
adm	4	Admin
bin	2	
daemon	1	
listen	37	Network Admin
lp	71	Line Printer Admin
noaccess	60002	No Access User
nobody	60001	Nobody
nobody4	65534	SunOS 4.x Nobody
nuucp	9	uucp Admin
root	0	Super-User
ssp	12	SSP User
sys	3	
uucp	5	uucp Admin

Host: Naturetech

Admintool: Add User

**USER IDENTITY**

User Name:

User ID:

Primary Group:

Secondary Groups:

Comment:

Login Shell:  /bin/sh

**ACCOUNT SECURITY**

Password:

Min Change:  days

Max Change:  days

Max Inactive:  days

Expiration Date:     
(dd/mm/yy)

Warning:  days

**HOME DIRECTORY**

Create Home Dir:

Path:

OK Apply Reset Cancel Help

### 5.3.1 User Name

---

This is the login name for the user. This is often an abbreviation or your initials.

### 5.3.2 User ID

---

The user ID is a unique number by which the network identifies a user account. Numbers 1 through 10 are reserved. You should consult the network administrator for your site for a valid number. If you are using your system as a stand-alone unit, use 100 for the first account, 101 for the next and so on.

---

### 5.3.3 Account Security

---

This section is used to specify how the password for the account is to be administered. Use this section to specify such as the required change frequency, expiration date and number of days warning are issued advising that the password should be changed.

### 5.3.4 Home Directory

---

This section creates a home directory for your new user account. You must enter a directory path in the text field. User accounts are normally located in /export/home. After you have entered your account details, click on OK and Solaris™ creates a user account based to your specifications.

## 5.4 Restarting The System

When you completed system configuration, carry out a complete system reboot by entering the command:

```
# init 0
```

This brings the system down to the ok prompt for power-off. You can shutdown system by pressing the Power button or use "power-off" command to power off system.

You can use power key by pressing   and select "Shutdown" to shutdown your system.

## Chapter 6 Using the Network Interface

This chapter provides information about networking concepts, with particular regard to mobile computing and describes how to connect your 777S to a network and configure the network interface.

## 6.1 Network Terminology

Some of the terms used in this chapter are explained below:

### 6.1.1 Client

---

A network *client* machine is a system that uses the services provided by a server machine for disk storage space, printer access or some other network-wide service.

**Domain** The name assigned to a group of machines within an organization on a site is called a *domain*.

### 6.1.2 DNS     **Domain Name Service (DNS)**

---

A service allows system on a network to find out the names of other systems on a network from a server.

### 6.1.2 Hostname

---

The name is given to a computer.

**Internet** The name given to a wide area network that spans the world.

Many computers connected to an Ethernet local area network (LAN) are part of or have access to the Internet.

### 6.1.4 IP Address

---

A unique number assigned to each machine on the network. Each system address has a corresponding system name, or hostname.

**NFS** The Network File System (NFS) allows you to use directories or files on a remote machine as if they were actually on your own computer.

### 6.1.5 NIS     **Network Information Service (NIS)**

---

A service allows system on a network to find out the names of other systems on a network from a server. This is not recommended for 777S that are frequently operated away from the network.

---

### 6.1.6 Server

---

A machine that provides services to other machines on the network, such as providing network-wide disk, backup or printing services.

### 6.1.7 TCP/IP

---

Transmission Control Protocol/Internet Protocol (TCP/IP) is a family of protocols that determine how data is transferred across a network.

Your 777S provides one Built-In RJ-45 Ethernet Jack; the internal Ethernet supports 10Base-T or 100Base-TX standard networks.

Before you use 777S on a network, it must be configured correctly.

## 6.2 An Overview of TCP/IP Networking and The Internet

All computers connected to an Ethernet network, either directly, can potentially access computers all over the world via the Internet. For this reason, every computer needs a unique identity so that data and messages can be sent and received anywhere in the world.

Although an in-depth study of networking is beyond the scope of this manual, this section provide a useful overview of how the Internet uses a system of network domains and internet protocol (IP) addresses to make data communications possible over the Internet.

### 6.2.1 Internet Addresses

---

Each device connected to a network must have a unique address and must have the unique address for each machine on the network to communicate for each other. *Internet Protocol* (IP) addresses are used to uniquely identify each machine on the Internet throughout the world. IP address allocation is normally managed by a single person at a particular site, often called the *system administrator*, who is responsible for the reliable operation and security of an organization's network.



**Note** – If you do not belong to an organization with its own internal network, you may gain access to the Internet via a modem through a local Internet Service Provider (ISP).

## 6.2.2 Classes Of Address

IP addresses consist of 32 bits and are normally written as four decimal numbers each in the range 0-255 and separated by periods. IP addresses have the following form:

a.b.c.d

For example, a typical IP address for a computer might be:

192.168.3.45

Any leading zeros are discarded.

The address functions in two parts: the first is used to identify a particular network; and the second is used to identify an individual computer, normally called a *host*, attached to that network. The proportion of the address used for each function depends upon the class of the network. There are three network classes, as summarized in Table below.

Class	Range	Network Portion	Host Portion	Likely Usage
A	1-126	a	b.c.d	Only the largest networks are assigned Class A addresses. Each Class A network has over 16 million available addresses.
B	128-191	a.b	c.d	Large organizations and groups of sub networks sometimes have a Class B address. The first and second numbers are assigned by the NIC, providing over 65000 available addresses for each Class B network.
C	192-224	a.b.c	d	Networks for the majority of companies are Class C networks. The first three numbers are allocated by the NIC, providing up to 254 available hosts for each Class C network.

The majority of smaller organizations use class C addresses, which provide 254 possible host addresses on their network. By convention, host address 0 is used to represent the network itself and 255 is used as a broadcast address. A message sent as every other host receives a broadcast on a network attached to that network.

In addition, address 127.0.0.1 is used as a *loopback address*; data sent to this address is transmitted back to the same host for testing. This address is usually given the hostname *localhost* in the */etc/hosts* file.

---

### 6.2.3 Addresses Used By Systems Not Connected To The Internet

---

By convention, sites that are not connected to the Internet use 192 or 193 as part a of their network address. However, even if you do not intend to access the Internet immediately, you are advised to obtain an official Internet address for your site.

---

### 6.2.4 Network Names

---

Although IP addresses provide computers with an efficient means of identifying the source and destination of data and messages transmitted across the Internet, it is much more intuitive for humans to use names. TCP/IP provides a flexible naming system, which allows this. The global Internet is organized into a hierarchical structure of *domains* that follow the network's organizational and geographical structure. At the top level, or *root domain*, the Internet is organized into a number of domains, which reflect the type of organizations or geographical territories within them. For example, .com identifies a *domain* used by commercial organizations most often in the United States. There also exist codes for individual countries such as .uk for the United Kingdom , .fr for France or .tw for Taiwan.

Commercial companies, educational establishments and government departments can access the Internet within these domains either directly or through an access provider. The Internet address for an organization consists of a name, which is unique to that organization.

For example, a company attached to the “.com.tw” domain could have the address: naturetech.com.tw

The diagram in Figure 8-3 shows three fictitious commercial organizations attached to the .com domain. An individual computer called *tsd* attached to a LAN segment within the company called naturetech would have the address: *tsd.naturetech.com.tw*

Individual users can be addressed using this scheme. For example, a user called Simon who uses *tsd* at naturetech, might have the address:

*simon@tsd.naturetech.com.tw*

Simpler email addresses may be recognized by a mail server, which uses database files to recognize the intended destination from Simon's email address of:

[simon@naturetech.com.tw](mailto:simon@naturetech.com.tw)

---

### 6.2.5 Accessing The Internet

---

To allow access to computers attached to other networks or to the Internet, a *router* or *gateway* is normally required. Computers with multiple network connections, which provide the necessary link between the Internet and an organization's internal LAN segments, perform the router or gateway functions. They ensure that data packets are routed according to destination. A gateway may also be used to provide security against unauthorized intrusion.

Each computer has a unique IP address and hostname, which allows data packets to be routed correctly between them and the outside world. Subject to access privileges, the various computers are able to share applications and files. In this case gate-1 functions as a *router* and controls data movement between this segment and any others within the same organization and provides access to the Internet.

---

### 6.2.6 Registering Internet Addresses

---

Internet addresses are allocated and administered globally by the DDN/ARPANET Network Information Center (NIC). An Internet address and domain name can be obtained directly from the NIC or from a network access provider who will register one on your behalf.

For further information, contact the NIC at the following URL

<http://www.nic.net>

## 6.3 Configuring 777S for a TCP/IP Network

The operations are required to configure your 777S for a TCP/IP network:

- Configuring a hostname and IP address
- Many organizations appoint an individual to be responsible for the reliable operation and security of their internal networks. This individual, sometimes known as the *network administrator*, should be consulted before connecting a new machine to the network. In particular, the network administrator will be able to advise you about the correct hostname and IP address to use for your 777S.
- Configuring your 777S to use DNS (optional)
- This may not be necessary for a small network, which rarely changes. However, as a network grows, the administrative burden of keeping each host up to date can be considerable. This burden is reduced on

many larger networks by designating one host as a *name server*. A name server provides a name-to-address mapping service for individual hosts within its domain allowing them to obtain the address information required for communication.

- Configure your 777S to use a router (optional)
- If your network is local and has no connection to other networks or to the Internet, this is not required. On some networks, one machine, or several machines on very large networks, will be configured as a *router*. A router controls the passage of data packets between network segments and ensures the efficient flow of data.
- Reboot and test the system.

### **6.3.1 Assigning a Hostname and IP Address**

---

Although you may have already assigned a hostname and IP address to your system during initial system configuration, you may need to change these details from time to time because your 777S is a mobile system and may be connected to different networks at different locations. If this is the case, you will need to consult the network administrator responsible for all networks you wish to connect to.

- Simple Configuration Using `ifconfig`
- The `ifconfig` command can be used to set the basic characteristics of the network interface, the most important of which is to associate an IP address with the interface. For example: `ifconfig eri0 192.168.3.45 netmask 255.255.255.0 broadcast 192.168.3.255`
- Configuring Your 777S by Editing the Hosts Files
- The `/etc/hosts` file traditionally contains the name-to-address mapping for every host on the network, including the local host itself.
- Whenever a new machine is added to the network, its own `/etc/hosts` file and the `/etc/hosts` file on each host already connected to the network must be updated to allow them to communicate.
- The initial configuration you carried out when you first powered your 777S on will have created an `/etc/hosts` file similar to the following:

```
#
# Internet host table
#
127.0.0.1 localhost
192.168.3.45 tsd loghost
```



**Note** – The address and hostname used here are examples only and would be substituted by your 777S.

You must add an additional line for each machine that you need to communicate with on your network. To edit the `/etc/hosts` file you must be logged in as root. You can edit the file using a text editor or with `vi` at the Solaris™ command prompt.

Each line contains the following information:

```
ip-number hostname #comments
```

For example, the following might be the host file for the network of machines:

```
#
# Internet host table
#
127.0.0.1 localhost
192.168.3.45 tsd loghost
#my new 777S
#
192.168.3.10 gate-1
# internet router
192.168.3.46 demo-1
192.168.3.47 demo-2
192.168.3.48 demo-3
192.168.3.49 demo-4
192.168.3.50 demo-5
```

### 6.3.2 Configuring 777S to use a Name Server

---

The 777S can be configured as a *Domain Name Service* (DNS) client by creating the configuration file `/etc/resolv.conf`. This file lists the local domain name and location of name servers for the local network. For example, in the case of the network where `gate-1` is the name server, `/etc/resolv.conf` would be similar to the following:

```
#
# Name Server Lookup
domain naturetech.com.tw
nameserver 192.168.3.10
```

The file could contain a list of several name servers, if required. The `/etc/hosts` file is much simpler for the DNS client and need only contain

the hostname and IP address of your own system and the name server. For example, the `/etc/hosts` for a machine attached to the network would be similar to the following:

```
#
# Internet host table
#
127.0.0.1 localhost
192.168.3.45 tsd loghost
# my new 777S
#
192.168.3.10 gate-1
# DNS name server
```

### **6.3.3 Setting up a Default Router**

---

Your 777S is configured to use a router by creating the file `/etc/defaultrouter` containing the IP address of the router. For example, the `/etc/defaultrouter` file for a machine attached to the network where `gate-1` is the router would be similar to the following:

```
# defaultrouter
192.168.3.10
```

### **6.3.4 Testing Your Network Connection**

---

When the entire necessary configuration files have been created and correctly edited, your 777S should be rebooted for the changes to take effect and the network connection tested.

The simplest way to test connections is using the `ping` command. This is a simple command to check network connect status. The command syntax is as follows:

```
# ping hostname
```

To use `ping`, you must logged in as root. For example, to test communications between your 777S to the local network, you may use the following command:

```
$ su
password:
# ping demo-5
demo-5.naturetech.com.tw is alive
```

You can obtain more detailed information by using the `-s` option with the command.

To test the Internet connection to a company called naturetech, you may use a command as below:

```
# ping naturetech.com.tw
naturetech.com.tw is alive
```

## 6.4 Sharing Filesystems

The Sun Network File System (NFS) allows you to set up distributed filesystems enabling files and applications on one host to be shared across the network by other hosts. This section provides a brief overview of how to set up a distributed filesystem using NFS.



- Many problems associated with Save and Resume arise when file sharing is being used. This is particularly true if you are running applications located on a server machine. The scenario is frequently as follows: you power off with a Save; remove your 777S from the network; and then attempt a Resume with no network connection. The server machine cannot be reached and the Resume cannot complete because your 777S cannot Resume the same operational state.
- To prevent this situation arising you should always observe the following precaution before powering off with a Save and removing your 777S from the network.
- Always unmount shared directories and comment out any lines in the `/etc/vfstab` file that automount an NFS filesystem by placing a `#` at the start of the line.

### 6.4.1 Exporting Local Filesystems

To allow other user to access parts of the filesystem on your 777S you *export* the filesystems you wish to share. To make the whole filesystem available, you would specify the root directory, but normally you would only allow access to specific files or directories.

### Configuring the /etc/exports file

The /etc/exports file controls access by other hosts to the local filesystem and consists of a number of lines containing the mount point followed by one or more hostnames, identifying the hosts which may access the exported filesystem. This file will not exist if you have not previously used NFS to export files but can be created and edited with a text editor such as vi. Each line has the following syntax:

pathname -option,option...Where:

pathname is the file or directory to be exported option specifies the type of access to be given, such as ro for read-only or rw for read-write access. For example, the /etc/exports file on demo-4 attached to the network might have the following lines:

```
/usr/anywork-rw=tsd, access=demo-5:demo-1, anon=-1
/usr/anybrowse-ro
```

In this example, tsd has read-write access to the directory /usr/anywork; demo-5 and demo-1 have read-only access; and the anon=-1 entry prevents any anonymous accesses. The second entry allows anonymous read-only access to /usr/anybrowse.

### Enabling file sharing

To allow these directories to be shared, you can either reboot the operating system (but not with Save and Resume) or use the following commands:

```
# nfsd 8 start 8 NFS daemons
# exportfs -a export the specified directories
# rpc.mountd start the mount daemon
```

If you have added directories to an already existing /etc/exports file the NFS daemons will already be running and you may only need to enter the exportfs command.

### Disabling file sharing

Before disabling file sharing, check whether any files are being shared with the exportfs command without arguments. This export a list of shared directories. You can unexport directories at any time by using the export -u command. For example:

```
# export -u /usr/anywork halt NFS access to /anywork
# export -ua halt NFS access to all directories
```

---

## 6.4.2 Mounting Filesystems

---

To share a directory that has been made available for sharing, or exported, you may use the mount command. This allows you to attach remote filesystems to your own filesystem tree and access them as a normal part of your own filesystem. You may need to create a directory as a mount point and then mount the remote filesystem.

For example, Simon on the machine tsd wishes to mount the directory /anywork, which resides on the machine demo-4, and access it within her home directory /export/home/simon in a subdirectory called /mywork.

The steps required would be as follows:

### Create the new directory

```
% mkdir /export/home/simon/mywork
```

This step is required if the directory does not already exist. However, using an existing directory, a mount point will prevent you from accessing files already in that directory while the remote filesystem is mounted.

### Mount the remote directory

```
# mount demo-4:/usr/anywork /export/home/simon/mywork
```

Mounting the remote directory on the local directory tree. Note that although this directory has the name /anywork on demo-4, accesses to the directory from the local host (tsd) use the name of the mount point /mywork.

For example:

```
$ ls mywork
```

```
File_1 File_2 File_3
```

---

## 6.4.3 Automatic File Mounting

---

You can specify a remote directory to be mounted automatically. To do this, you need to log in as root and add a line to the /etc/vfstab file using a text editor, such as vi.

For example, to automount /usr/anywork on a machine called demo-4 as /mywork on a machine called tsd (as in the previous example), the following line would be added to the /etc/vfstab file on tsd:

```
demo-4:/usr/anywork - /export/home/bs/myworknfs - yes rw,hard,intr
```

Where the fields are assigned as follows:

**device to mount**

This is the device name for a local file system or host:pathname for a remote directory.

**device to fsck**

This specifies raw device to fsck. In the case of an NFS filesystem, a dash (-) should be used.

**mount point**

This is the directory where the remote filesystem is to be mounted. The directory must exist for the mount to succeed.

**FS type**

This is the type of filesystem which is normally ufs for a local filesystem or nfs for a network filesystem.

**fsck pass**

This is the number of times a filesystem checks to be carried out. In this case a dash (-) means none. This is normally 1 for the root filesystem, 2 for all other local filesystems or 0 for remotely mounted filesystems.

**mount at boot**

This specifies whether or not the filesystem is mounted automatically at boot time.

**mount options**

This field specifies mount options, such as read-only (ro), read-write (rw) and no super user privileges (nosuid). Other useful options for remotely mounted filesystems are hard and intr which together enable the local user to interrupt (with Ctrl-C) or to kill hung processes which may occur if the network link is disrupted.

---

**6.4.4 Unmounting a Remote Filesystem**

---

Remote files can be unmounted using the umount command. For example:

```
# umount anywork
```



Caution : Unmounting is recommended whenever you have the intention of using your 777S away from the current network. Always unmount remote filesystems before a Save if the filesystem is not going to be available when you Resume.

---

## 6.5 Executing Remote Commands

A number of commands are provided by TCP/IP, which can be executed remotely on other machines on the network, subject to permissions. The most important of these commands are as follows:

- rcp** Lets you copy files over the network between UNIX hosts.
- rlogin** Lets you log in to remote UNIX hosts over the network on which you have an account. You may have to supply a password if the remote system has been set up to test for one.
- rsh** Lets you execute a single command on a remote UNIX host.
- ftp** For file transfer protocol, allows you to copy files over the network between hosts.
- telnet** Allows you to log in to any reachable remote system on which you have an account.
- finger** Allows finding out information about users on remote systems.

### 6.5.1 Copying Files

---

The syntax for copying files with rcp is as follows:

**% rcp [-r] [fromsys:]filename [tosys:]filename**

For example, to copy the file swdemo from the current directory on the local machine into the /tmp directory on the machine called demo-1, you would use the following command:

**% rcp swdemo demo-1:/tmp/swdemo**

Note that you do not need to specify the name of the local host in the command.

### 6.5.2 Remote Program Execution

---

You can execute a single command on a remote machine without having to log in, provided that you have the necessary privileges. The command syntax is as follows:

**% rsh sysname command**

For example, to list the files in /home on the machine called demo-1 you would type the following:

**% rsh demo-1 ls /home**

---

**6.5.3 PPP**

---

When your 777S is connected to a remote network via a PPP connection, most of the commands can be used when attached to the local network. That means the network printer can be used and mail may be sent from your 777S. Cable should be taken when disconnecting to a PPP connection and PPP data transfers are completed. Data/Information will be lost if the interface is detached while a transfer is in progress.



## Chapter 7 Remote Computing

This chapter discusses how to use your 777S for remote communications via a modem.

## 7.1 Getting Connected

777S allows you to connect an external standard serial modem. Connect the RS232 cable between the external modem and the serial port of 777S. Then connect the telephone line to the RJ11 jack of external modem.

### 7.1.1 Checking modem status

---

You can check modem status by using the tip command with the appropriate label.

For example, the following command opens a command line interface to the external modem:

```
% tip /dev/cua/a
connected
```

This allows you to control the modem directly with the AT command set. To break the command interface, enter ~. (tilde period), that is:

```
~.
[EOT]
%
```

## 7.2 Simple Terminal Login Connection

To open a simple terminal login connection to a remote system, you can use the tip command. The tip command allows you to open an AT command interface for the modem, as described in the previous section, or to dial up remote UNIX or non-UNIX systems and to login to an interactive login session, although you may require a login account on the remote system.

For example, to dial out using an external modem, you could use the sequence:

```
% tip /dev/cua/a
atdt012345678
```

Where at informs the modem that the following sequence is a Hayes command and the number is the number to be dialed. The number includes the tone-dial characters "t".

Once the link is established, the actions taken depend upon the configuration of the remote machine. The tip utility supports the following escape sequences:

- ~! Escape to a command prompt on the local system. The connection remains in place and typing Ctrl-D returns you to the remote system.
- ~t from [to] Copy a file from the specified file on the remote system to a file on the local machine. If to is omitted, the same file name is used.
- ~%p from [to] Copy a file from the specified file on the local system to a file on the remote machine. If to is omitted, the same file name is used.
- ~? Get a summary of tilde escapes.
- ~. Terminate the connection.

### 7.3 Remote Network Access

Your 777S supports connection to a local network in the same way as any SPARC-based workstation running the same operating system. In addition, it supports remote connection to a network using the external modem and a telephone line.

Your 777S supports one remote network connection protocols as follows:

- Point-to-point protocol (PPP)

Once setting up, PPP can be used to transfer Internet packets via a telephone line. All of the regular network applications can be used, although the limited bandwidth of the link may make transferring large files a lengthy process.



**Note** – PPP is only available on Solaris™ 8 (or later); it is similar to SLIP, but includes sophisticated negotiation, which improves data transfer rates and minimizes configuration overhead.

In order to gain access to a network using the PPP, you must connect, via a telephone line and modem, to a computer that will function as a gateway (or *dialup server*) to your organization's office network or to the Internet. This might be provided by your own organization or by an Internet service provider.

The server must be attached to the network with which you need to communicate and must support PPP via the modem. You will need to consult the system administrator or service provider for advice on this.

## 7.4 Setting Up PPP

The Solaris™ PPP allows you to use a serial line or modem as a network interface to transfer Ethernet packets between systems. The facility queues transfer requests between your 777S and remote systems and unlike tip; does not create a permanent connection but calls the remote system when required to perform a task. A timeout period is set in the configuration files so that the modem hangs up automatically if there are no processes pending.

The steps required to get PPP operational on your 777S are as follows:

1. Load the Solaris™ PPP packages onto your 777S, if necessary.
2. Edit the /etc/hosts file on all machines to be connected.
3. Edit the uucp database files for all dial-out systems.
4. Edit the /etc/passwd and /etc/shadow files for a dial-in machine. You will need to consult the system administrator if this is an organization's dial-in server.
5. Edit the /etc/asppp.cf file on each machine on the link.
6. Test the link.

For further information about PPP, please refer the Solaris™ documentation.

You can find another way to set up PPP via GUI Internet Dialer.



For further information, please refer the documentation at the following URL: <http://www.kempston.net/solaris/dialer.html>

### 7.4.1 Starting And Stopping PPP

---

Solaris™ PPP will normally start up during the system boot process. However you can start PPP manually with the following command while logged in as root:

```
# /etc/init.d/asppp start
```

You can verify that it is running with the following command:

```
# ps -e | grep asppp
```

This should produce output, which will list the aspppd daemon if PPP is running. You can stop PPP manually with the following command:

```
# /etc/init.d/asppp stop
```

### 7.4.2 Testing The Link

---

If your modem is correctly installed and the /etc/hosts files, UUCP database files and PPP are all correctly edited and you have the correct dial-in access to the server machine, the link can be tested with the ping command. For example on the 777S simon, you could use the command:

```
# ping gate-1-p 180
```

```
gate-1-p is alive
```

Your 777S should dial the remote system and then, after some delay while the connection is being established return output similar to that shown. The 180 arguments, in this example, sets a timeout of 3 minutes to allow time for the connection process to complete before reporting a failure.

## 7.5 Electronic Mail

777S provides facilities for sending and receiving electronic mail (or email). While working as part of a larger network of machines, the network itself normally provides email facilities. It is also possible to set up your 777S as a complete stand-alone email system. In this mode it functions as a stand-alone domain on Internet and is able to send and receive mail directly to and from any other Internet user. To do this, you need to register with an Internet mail feed organization as a new Internet node.

### 7.5.1 Setting Up Email

---

777S is shipped ready to use existing Ethernet-based mail facilities. If you attach to a network that already provides email facilities, you need to contact your network administrator so that your name can be added to those that the mail server knows about.

In order to access the mail facilities when you are away from the network, you need to arrange for your mail to be forwarded to another machine, acting as a remote dial-in mail server. You can then use a modem to contact the remote server via a dial-in line to send and receive mail. You will have to consult the administrator for the server to obtain an account on the remote server.

## 7.6 AT Command Set

It is possible to control the operation of the modem directly from the command line using the Hayes-compatible AT command set. This section describes some of the more commonly used commands in the AT command set.

The command set is supported by the external modem. To respond to AT commands, the modem must be placed in Command Mode from the Solaris™ command line using the tip command:

```
% tip su0 External Modem
```

When in Command Mode, the modem accepts instructions in the form of command lines returns status information in response to some of them. The modem can be instructed to perform functions such as originating or answering calls or can be configured to change its mode of operation. Modems can store two configuration profiles and four telephone numbers while powered off.

With the exception of A/, all command lines begin with the attention characters AT followed by one or more command characters and are terminated by pressing ENTER. Command lines may contain up to 56 characters, including A and T. All characters before the AT string and all characters that follow an errant command are ignored.

The modem can be returned to normal operation by typing in ~. (tilde period).

CODE	DESCRIPTION
A	Go Off-hook in Answer Mode
A/	Re-execute Previous Command
AT	Attention Characters
B	Bell/CCITT Protocol
D	Dial Telephone Number
En	Command Echo
Fn	Select Line Modulation
Hn	Switch Hook Control

---

In	Identification
Nn	Automode
O	Return to Online
P	Set Pulse Dialing Default
Qn	Quiet Command Reset Code
Sn	Read/Write From Selected S-Register
T	Set Tone Dialing Default
V	Enable Short-form Result Code
Wn	Error Correction Message Control
X	Enable Extended Result Code Set
Y	Long Space Disconnect
&Fn	Restore Factory Configuration
&V	Display Current Configuration and Stored Profiles
&W	Store Current Configuration
&Yn	Designate a Default Profile
&Zn=x	Store Telephone Number
%Cn	Enable/Disable Data Compression
%En	Enable/Disable Auto Retrain
*B	Display Blacklisted Number
*C	Remote Configuration Password
*D	Display Delayed Numbers
*E	Exit Remote Configuration Mode
*L	Display Secure Access Directory
*P	Store Callback Password
*R	Request Remote Configuration

### 7.6.1 AT Command Set Description

---

A/	Re-execute Previous Command This repeats the last command. It is not preceded by the AT characters or terminated by pressing ENTER.
AT	Attention Characters These characters must appear at the beginning of all command lines.
Bn	Bell/CCITT Protocol This command selects the communication standard: n = 0 CCITT operation n = 1 Bell
Dn	Dial Telephone Number

This command causes the modem to dial up a remote modem. The following modifiers may be added:

L Redial last number  
 P Pulse Dialing  
 T Touch-tone Dialing  
 R Originate Call in Answer Mode  
 W Wait for dial tone for a time defined by S6  
 , Delay dial sequence for a time defined by S8  
 @ Wait for Quiet for a time defined by S7  
 ! Go On-hook for a time defined by S29  
 ; Return to Command Mode  
 S=n Dial a Stored Number

En Echo Command Characters

This controls whether the modem echoes command characters back to the host:

n = 0 Disable Character Echo  
 n = 1 Enable Character Echo

Fn Select Line Modulation

This selects line modulation:

n = 0 Auto Dial mode  
 n = 1 V.21 or bell 103 (according to Bn)  
 n = 2 Reserved  
 n = 3 V.23  
 n = 4 V.22 at 1200 bps  
 n = 5 V.22 bis  
 n = 6 V.32 bis at 4800 bps  
 n = 7 V.32 bis at 7200 bps  
 n = 8 V.32 bis at 9600 bps  
 n = 9 V.32 bis at 12000 bps  
 n = 10 V.32 bis at 14400 bps

Hn Switch Hook Control

n = 0 Go on-hook (hang up)  
 n = 1 Go off-hook to access the telephone line

In Identification

This causes the modem to respond with identification codes:

n = 0 Request Product Code  
 n = 1 ROM Checksum

	n = 2 Return OK Response
	n = 3 Manufacturers ID
	n = 4 Configuration Mode
	n = 33 Sierra ID
O	Return to Online
	This command returns to the modem to the Data Mode.
Qn	Command Response Control
	This controls whether the modem provides responses to commands:
	n = 0 Return Response
	n = 1 Do Not Send Response
Sr=n	Change Register Value
	This selects an S register and changes its contents:
	r = S register
	n = New Contents
Sn?	Read S Register
	This returns the contents of an S register
	n = S-register
Vn	Response Format
	This command is used to select the format of response made by the modem to the host:
	n = 0 Single Digit Response
	n = 1 Extended Response
Xn	Select Extended Response Set
&Fn	Fetch Factory Configuration
	This recalls the factory settings of the modem.
	n = 0 Recall factory profile 0
	n = 1 Recall factory profile 1
&V	Display Current Configuration and Stored Profiles
	This displays the currently active configuration, the stored profiles and first four stored telephone numbers.
&Wn	Store Current Configuration
	Store the currently active configuration, including S registers, as a profile n (0 or 1).
&Yn	Designate a Default Profile
	Selects the profile used after a hardware reset.
&Zn=x	Store Telephone Number
	The modem can store up to 20 numbers:

- n = Number memory 0 – 19  
x = Dial string of up to 40 characters
- %Cn** Enable/Disable Data Compression  
n = 0 Disable data compression  
n = 1 Enable MNP 5 data compression  
n = 2 Enable V.42 bis data compression  
n = 3 Enable V.42 bis and MNP 5 compression
- %En** Enable/Disable Auto Retrain  
This controls whether the modem automatically monitors the line quality and requests a retrain when needed:  
n = 0 Disable auto retrain  
n = 1 Enable auto retrain
- \*B** Display Blacklisted Numbers  
This causes the modem to return a list of blacklisted numbers.
- \*C** Remote Configuration Password  
This instructs the modem to store a password. By supplying a matching password, a remote modem may reconfigure the local modem supplied by a remote modem.
- \*D** Display Delayed Numbers  
This causes the modem to send a list of delayed numbers and the delay associated with each.
- \*E** Exit Remote Configuration Mode  
This causes a remote modem to exit remote configuration mode and transmit OK onto the telephone line.
- \*L** Display Callback Directory  
This causes the modem to supply a list of all callback directory entries.
- \*P** Store Callback Password  
This causes the modem to store a password and to store or delete a corresponding telephone number. The password is used to match that supplied by a remote modem when secure access is used. The number is used to dial back the remote modem.
- \*R** Request Remote Configuration  
This causes the modem to attempt to place a remote

modem into remote configuration mode. This is only possible if the local modem is in the online command mode and is connected to the remote modem by an MNP error corrected link.

## 7.7 Class 2 Fax Command Set

The external modem of 777S is able to execute extended Class 2 Fax Commands. These commands must be preceded by the AT characters and terminated with a semicolon (;) or Enter.

COMMAND	FUNCTION
Service Class ID	
+FCLASS=	Service Class
Class 2 Action Commands	
D	Originate a Call
A	Answer a Call
+FDT=	Data Transmission
+FET=N	Transmit Page Punctuation
+FDR	Begin or Continue Phase C Receive
Data	
+FK	Session Termination
Class 2 DCE Responses	
+FCON	Facsimile Connection Response
+FDCS	Report Current Session
+FDIS	Report Remote Identification
+FCFR	Indicate Confirmation to Receive
+FTSI	Report the Transmit Station ID
+FCSI	Report the Called Station ID
+FPTS	Page Transfer Status
+FET	Post Page Message Response
+FHNG	Call Termination with Status
Class 2 Session Parameters	
+FMFR?	Identify Manufacturer
+FMDL?	Identify Model
+FREX?	Identify Revision
+FDCC=	DCE Capabilities Parameters
+FDIS=	Current Sessions Parameters
+FDCS=	Current Sessions Results
+FLID=	Local ID String

+FCR	Capability to Receive
+FPTS=	Page Transfer Status
+FCR=	Capability to Receive
+FAA	Adaptive Answer
+FBUF?	Buffer Size (Read Only)
+FPHCTO	Phase C Time Out
+FAXERR	Fax Error Value
+FBOR	Phase C Data Bit Order

## **Chapter 8 Installing and Using Applications**

This chapter provides details about running third-party applications, and outlines any limitations that may apply.

## 8.1 Third-Party Application Support

The 777S use 100% SPARC architecture, so 777S is 100% compatible with all applications for Solaris 8 such as a conventional desktop SPARC workstation. Applications that meet the SPARC Compliance Definition (SCD) will be fully supported for 777S.

In general, all third-party X or OpenWindows applications written for SPARCstation and compatible workstations will run on the 777S with very few limitations as follows:

- Applications use either X-windows as their graphics system or must be written for OpenWindows. The operating system uses X-windows Release 6 and OpenWindows Version 3.4, but you can run earlier X-windows or OpenWindows applications directly on the 777S. Older SunView applications aren't supported.
- Applications that require the existence of Sun specific hardware, such as attached PCIBus hardware, or that make direct calls into undocumented device driver interfaces in the Sun kernel, will not run on the 777S.
- Applications that use Sun or other vendor specific hardware (such as IDPROMs) for licensing may not run on the 777S.

## 8.2 Methods Of Installing Applications

Software installation on the 777S is carried out in a conventional manner. Programs can be installed to run locally or can be run on a network server. However, due to the mobile test of the 777S, which may mean it is operated without a network connection from time to time, it is advisable to install applications onto your own hard disk and then run them locally. You can install applications from a locally connected drive or from a network server. In addition, application vendors are increasingly using the World Wide Web to distribute their products.

Applications can be installed using one of the following methods:

- From a locally connected CD-ROM, tape or floppy drive
- From a network server
- From a remote website

For specific information about installing SPARC applications onto 777S, refer to the documentation supplied with the application and to the Sun documentation.

### 8.3 Applications And Graphics Interfaces

777S uses a standard X-server interface to set the display interface's operating parameters. In addition to supporting the built-in display, the 777S can be set up to support a wide range of external displays. Also, the unique emulated frame buffer feature allows the X-server resolution to be set independently of the physical resolution of the display. Applications operate independently of the physical display's resolution because they are only aware of the X-server's resolution.

The default resolution is 1024 x 768 for the built-in display. For more information, please refer to man pages.

### 8.4 Legibility Of Text On A Small Screen

When using some display resolutions, you may find that text elements within windows and menus become very small. Both OpenWindows and CDE allow you to increase the size of text used in windows, menus and alert messages.

- **Changing Text Size in OpenWindows**  
To change the font size used in OpenWindows, select Workspace Properties from the Workspace menu and then select Fonts from the Category menu. Within the fonts category window, select the required font style and size.
- **Changing Text Size in CDE**  
To change the font size used in CDE, select the Style Manager icon from the Front Panel and then select the Font icon from the Style Manager window. In the Font window, select the required font size and then click OK.

The change takes effect immediately for applications launched after the change is made. However, to make the change take effect for CDE, you must exit and then re-enter CDE.

## 8.5 Customizing the Operating System

777S preload of Solaris™ 8 update 4 and greater is a standard Sun end user product. Many of the facilities available on the complete Solaris™ operating system CD-ROM are not required by every user or are only occasionally needed. To save disk space, some less used facilities are not installed during the factory install process.

This section explains how to add facilities to your system by installing packages from the Naturetech distribution CD supplied with your 777S or from the Sun Solaris™ CD. The instructions should be read in conjunction with your Sun Solaris™ documentation.

### 8.5.1 Installing Packages

The basic procedure for adding packages is as follows:

- Connect a CD-ROM drive, either directly to your 777S or to a server, containing the Naturetech or Sun distribution CD. Consult the system administrator, if required, for advice on using the CD-ROM with a server.
- Create the necessary device file (`/dev/dsk/c0t0d0s0`), if it does not already exist, to read the CD-ROM. The device file can be created at boot time or without powering down, as described below.
- Mount the CD-ROM onto your file system.
- Use the `pkgadd` command to install the required packages.

Connecting the CD-ROM

Connect the CD-ROM to your 777S

Creating the Device Files – Boot Time

To create the special device files during boot time, use the following procedure:

1. Press the Power button.
2. When the OpenBoot start-up screen is displayed, press FN-Stop-A.



ok

```
Naturetech Ultra-NoteStation 777S (UltraSPARC IIe 500 MHz) ,  
Keyboard Present  
OpenBoot 4.0, 512 MB memory installed, Serial # 8388622  
Ethernet address 0:2:11:80:0:e, Host ID:8080000e.
```

Figure 7-1 - OBP Banner Example

Enter the following commands:

**ok boot -r**

The -r option causes the 777S to carry out hardware reconfiguration. In this example, the 777S detects the CD-ROM and creates the necessary special file /dev/dsk/c0t0d0s0 to allow the CD-ROM's filesystem(s) to be accessed.

- **Creating Device Files – On a Live System**

It may be necessary to add an external CD-ROM drive to a 777S without powering the system down in order to allow uninterrupted access to available filesystems.

In this case, the device file described above can be created as follows:

1. Become superuser.
2. Enter the following commands:

```
# drvconfig -i sd
# disks
```

- **Create the Mount-Point and Mount Your CD-ROM**

To do this, login as root and enter the following commands:

```
# cd /
# mkdir /cdrom
# mount -r /dev/dsk/c0t0d0s0 /cdrom
```

- **Installing the Packages**

The pkgadd command is used to install the required packages. For example, to add a package to a Solaris™ 8 release, type:

```
# pkgadd -d /cdrom/Solaris_8 packageA
```

Follow the displayed instructions to complete the installation procedure.

You can add several packages at one time by specifying the required package names separated with a space. For example:

```
# pkgadd -d /cdrom/Solaris_8 packageA packageB
```

---

Note – The name of the directory Solaris\_8 differs between versions of the operating system. You can ascertain the correct name by listing the contents of the CD-ROM. That is: ls /cdrom.

---

---

### 8.5.2 Displaying Package Information

---

To display information about all packages that are already installed, type:

```
# pkginfo
```

Information about the installed packages is displayed on your screen.

Alternatively, to display information about specific packages, you can pipe the output of `pkginfo` into a `grep` command. For example, the following command could be used to display the PPP packages installed on your 777S:

```
# pkginfo | grep ppp
```

---

### 8.5.3 Removing Packages

---

To remove packages, use the `pkgrm` command. For example:

```
# pkgrm packageA
```

You can remove several packages at one time, by specifying the package names separated with spaces. For example:

```
# pkgrm packageA packageB packageC
```

## 8.6 Memory Usage And Swap Space

The Solaris™ operating system uses *virtual memory* to allow several applications to run simultaneously when they would otherwise require more memory than is physically present in the system. To support this feature, one of the disk partitions on the boot disk is assigned to provide your 777S with 'swap space'. This allows parts of programs that are not running at any given moment to be stored (or swapped) temporarily on to the hard disk while active applications are running in main memory. The effect of this is to make your memory appear to be much larger than it really is.

The swap partition created by the "factory install" on your hard disk drive is large enough to allow a reasonable number of tools and applications to be used simultaneously.

Table below shows the sizes used for the swap partition for the different memory capacities.

Memory (MB)	Swap size (MB)
256	512
512	1024
1024	2048

### 8.6.1 Using Swap Space Efficiently

---

All applications require a certain amount of memory to be available before they will start up. Your memory can soon be used up if you start up many applications and leave them all running on the OpenWindows or CDE workspace. Typically, if you were running one or two applications together with a Mail Tool, a clock and a File Manager you would have no problems. However, if you run a large number of complex applications you are likely to run out of memory and swap space.

To minimize your memory and swap usage bear the following points in mind:

- Minimize the number of DeskSet tools in use. The tools use large amounts of memory. For example, if you only use the Calendar Manager occasionally, call it up from the Workspace menu when you need it rather than leaving it as an icon on your workspace.
- Avoid using tools that use memory continuously or often. For example, the performance meter tool runs every second. Similarly, if you enable the second hand on the clock, the clock program must run every second.
- Keep your mail in mailfiles if you have more than a few messages. Each message that appears when you open your mail file takes memory.
- Keep tools iconified if you are not using them, but do not want to quit them. For example, the performance meter and the File Manager tools are suspended when they are iconified, freeing up memory (but not swap space) for other processes.
- Arrange tools on the screen so they do not overlap. This reduces repainting by the Window Manager.
- If you are using the multi-browser in the Calendar Manager, quit it

when you are finished rather than iconizing it, it is almost as quick to restart it from the Calendar Manager as it is to open it from the icon.

- Avoid using a background image for the main background; plain backgrounds use less memory.
- Avoid using PostScript applications at the same time as OpenLook applications.
- Do not try and run too many applications at once. You may have to reduce the number of different applications active or on the DeskTop if you want to run a new large application.

### **8.6.2 Checking Swap Space Usage**

---

You can find out how much swap space you are using at any time by using the following command:

```
% swap -l
```

This prints out the amount of swap space available and in use.

### **8.6.3 Adding Swap Space**

---

You can create and add additional swap space without reformatting the disk. For example, the following steps create a 512Mbyte file for use as extra swap space (you will need to be superuser or logged in as root to do this) as follows:

1. Create a swap file using the following commands:

```
# mkdir /swap
```

```
# cd /swap
```

```
# mkfile 512m SWAPFILE Make a 512Mbyte file
```

2. Add the swap file to the system by editing you should add lines such as the following to the file /etc/vfstab:

```
/swap/SWAPFILE - - swap - no - no-
```

3. Restart your system using a full system startup

## **Chapter 9 System Backup and Restore**

This chapter describes the backup/restore facilities provided as part of the implementation of Solaris™. In particular it provides an example of how to use `ufsdump` and `ufsrestore` to backup and restore filesystems.

## 9.1 Overview

System hangs and hard disk problems are hazards even with the most reliable computer systems, including your 777S. Problems may be caused by operator error or by software or hardware failures.

For this reasons, it is vital to maintain regular backups of your work and of essential system configuration files.

### 9.1.1 Backup Strategies

---

777S usage and filesystem structures vary widely from system to systems, which means that your backup strategy must be appropriate for your individual needs. You should consult the system administrator of your organization to advise you on the best strategy for you and the facilities available. The following observations may help in devising your strategy.

- Your 777S runs the standard Solaris™ operating system with backup capabilities identical to those of a conventional desktop system, including `tar`, `cpio` and `ufsdump`.
- Consider also how cumbersome different media and drives to carry around with your 777S and whether you are able to power any external drives in a different country.

### 9.1.2 Further Information

---

The Solaris™ operating system contains many facilities for automated backup in a large networked environment. This manual can only describe very basic backup and restore facilities. For a complete description of the backup and restore capabilities of Solaris™ you will need to refer to Sun's publications.

## 9.2 File Backup Facilities

For most purposes, `tar` and `cpio` are adequate for saving important files to tape or floppy. They are sufficient to save small amounts of data and have the advantage of allowing you to back up both local and remote filesystems mounted via NFS.

For example, the `tar` command could be used to make a backup of your

/export/home directory to tape as follows:

```
$ tar cvf /dev/rmt/0 /export/home
```

As another example, to save the file mywork to a floppy disk, the command would be as follows (the disk must be formatted):

```
$ tar cf /dev/diskette mywork
```

To list the contents of the archive on the floppy in the form displayed by ls -l, the command would be:

```
$ tar tvf /dev/diskette
```

To extract the archive from the floppy the command would be:

```
$ tar xvf /dev/diskette mywork
```

For further information about tar and cpio, please consult the Sun Solaris™ documentation.

## 9.3 Backing Up Filesystems

To make backups of a complete filesystem (or single disk partition), the ufsdump command provides an alternative. The general syntax for the command is as follows:

```
# ufsdump options arguments filesystem
```

Where options are a list of options to be used for this backup and arguments is a list of arguments that correspond to the list of options in the *same order*.



### Caution

It is important to supply the arguments in the same order as their corresponding options. For example:

```
ufsdump 0sd s-arguments d-arguments filesystems
```

Failing to observe the correct order could completely destroy the filesystem being backed up.

### 9.3.1 Backing Up Onto 2<sup>nd</sup> Hard Drive

Disk partitions can also be backed up to another locally connected disk drive with the ufsdump command. The disk in that example had one large filesystem called /external mounted on root.

For example, to backup each partition in turn to a 2<sup>nd</sup> hard disk, the commands would have the following form:

```
# ufsdump 0f /external/usr_arch_ddmmyy /usr
```

Where: /usr\_arch\_ddmmyy is the name of the dump file. The \_arch element used in this example is an arbitrary reminder to the user at a future date that this is an archive, and ddmmyy provides an arbitrary date stamp.

## 9.4 Restoring Filesystems

Filesystems can be restored from an ufsdump archive using the ufsrestore command.



### Caution

It is important to restore the partitions in the same order they were backed up.

Restore procedure is listed as follows:

1. Connect the backup drive to your 777S.
2. Power on your 777S and external drive.
3. If you are using a tape device, ensure that the backup tape is rewound by logging in as root and entering the following command at the Solaris™ prompt (assuming that the backup device used was /dev/mnt/0n):

```
# mt -f /dev/rmt/0n rewind
```

4. Reset your 777S by entering the following commands:

```
# halt
```

5. Boot the system with the following command:

```
ok boot -r
```

6. Log in as root and then at the Solaris™ prompt, restore each partition in turn with the following sequence of commands:

```
# cd /
```

```
# umount /mnt
```

```
# mount /dev/dsk/c0t0d0s0 /mnt
```

```
# ufsrestore -rf /dev/rmt/0n
```

Restore the root filesystem to your hard disk.

```
# cd /
```

```
# umount /mnt
```

```
# mount /dev/dsk/c0t0d0s3 /mnt
```

```
# ufsrestore -rf /dev/rmt/0n
```

Restore the var filesystem to your hard disk.

```
# cd /  
# umount /mnt  
# mount /dev/dsk/c0t0d0s5 /mnt  
# cd /mnt  
# ufsrestore -rf /dev/rmt/0n
```

To restore the opt filesystem to your hard disk.

```
# cd /  
# umount /mnt  
# mount /dev/dsk/c0t0d0s6 /mnt  
# cd /mnt  
# ufsrestore -rf /dev/rmt/0n
```

This restores the usr filesystem to your hard disk.

**7.** At the Solaris™ prompt, enter the command:

```
# cd /  
# umount /mnt
```

**8.** Reset your 777S by reboot



## Chapter 10 System Upgrade Information

## 10.1 Overview

This chapter provides operating instruction for memory upgrade and Solaris/OBP update. The modular design for memory is easy to be upgraded. For Solaris update, please contact your dealer for reference. Naturetech will issue new firmware (OBP) file, you may browser our website for update news.

## 10.2 Upgrading The Main Memory

The process of upgrading your system's memory consists of two basic steps:

- Memory upgrade notice
- Upgrade memory

### 10.2.1 Memory upgrade notice

The partition layout for your hard drive is always depends on your memory size. The only reason for memory upgrade is system performance. And the SWAP partition will depends on your memory size. If you upgrade memory, the SWAP partition needs to be change to increase system performance. If you just upgrade memory and do not re-layout your SWAP partition, you will not achieve better performance.

Regarding to this reason, we recommended you contact your dealer for memory upgrade. Unfamiliar operation will damage the system/memory. Always find a qualify technician for memory upgrade.

Naturtech will provide two types of memory modules for DIMM1 and DIMM2, the memory module only provided by Naturetech. There will be a label for each memory to identify. Each memory must be install in each DIMM for normal operation.

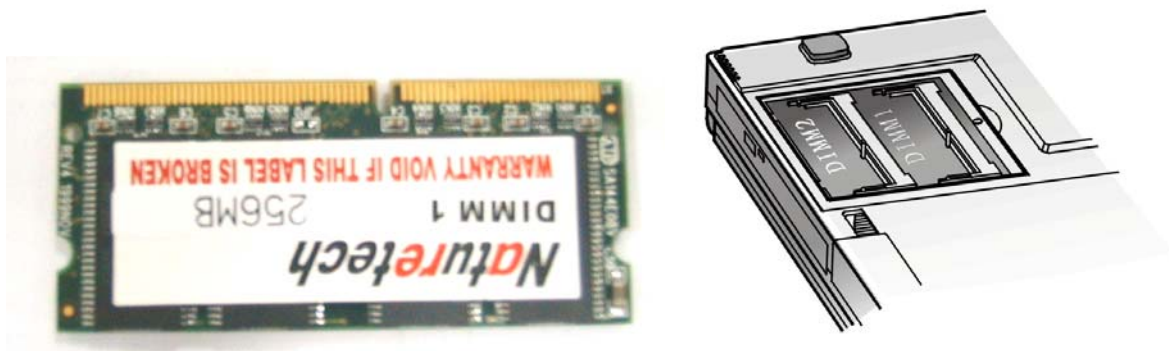



### Note – Memory Module

The 777S supports only buffered PC133 type Non-standard ECC (Error Checking & Correction) SDRAM S.O.DIMM. System is equipped with two 144-pin S.O.DIMM sockets. Do not install memory yourself. Contact vendor for upgrade memory. The default memory size is 256MB.

## 10.2.2 Upgrade Memory

The 777S model can be upgraded up to 1GB (1024MB) for total memory. 777S provides two 144-pin non-standard SDRAM S.O.DIMM for memory. Naturetech only provide two kinds of memory size for upgrade.

<b>Max. Supported Memory</b>	1GB
<b>Possible Memory Configurations</b>	256MB / 512MB / 768MB / 1GB
<b>Memory Sockets</b>	Two 144-pin SDRAM S.O.DIMM
<b>ECC features</b>	Single bit Error Checking & Correction Double bit Error Checking & Correction

## 10.2.3 Remove the memory module

1. Shutdown the system and turn over the 777S.
2. Find the RAM cover as figure below.

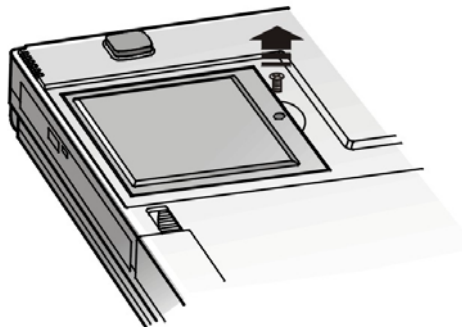

3. Remove the screw and then remove the RAM cover.
4. Gently release the memory latches outward until the DIMM pops up.

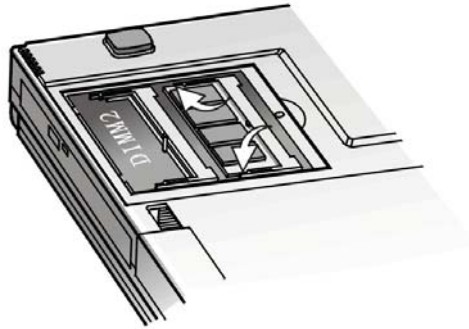

5. Pull out the memory to remove memory module.

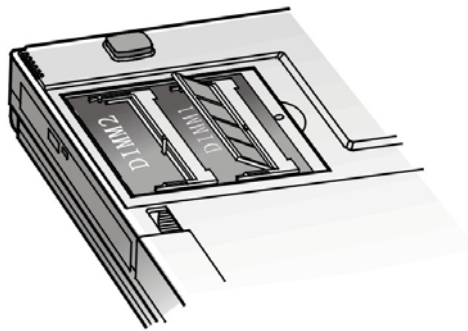

#### 10.2.4 Upgrade Memory

1. Gently slide the memory module into memory S.D.DIMM in a 30~45 degree.

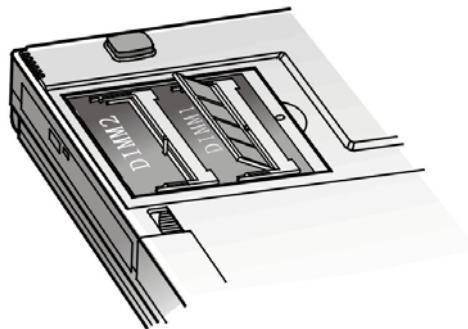

2. Gently push down the memory module downwards until the latches click into place.
3. Replace the RAM cover.

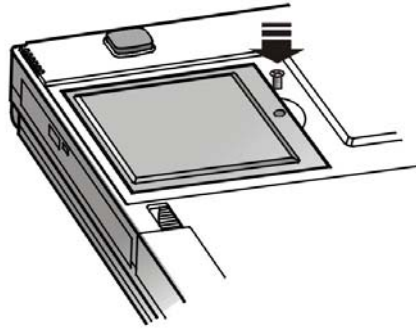

### 10.2.5 Checking the memory capacity

---

1. Power on your system.
2. When the OpenBoot greeting is displayed, press FN-Stop-A.
3. Check that the new memory capacity is correctly reported on the banner.
4. Power off by pressing Power button or “power-off” command.
5. You can display the banner information by “banner” command in the ok prompt.

### 10.3 Upgrading Solaris™

For more information about Upgrading Solaris, please refer to your Solaris™ documentation or contact your dealer.

### 10.4 Upgrading Firmware

Naturetech will release the latest firmware binary file for upgrading OBP on Web Site (<http://www.naturetech.com.tw>). After you download the latest firmware binary file, place the file to your hard drive or floppy diskette and double click the script to execute update process.

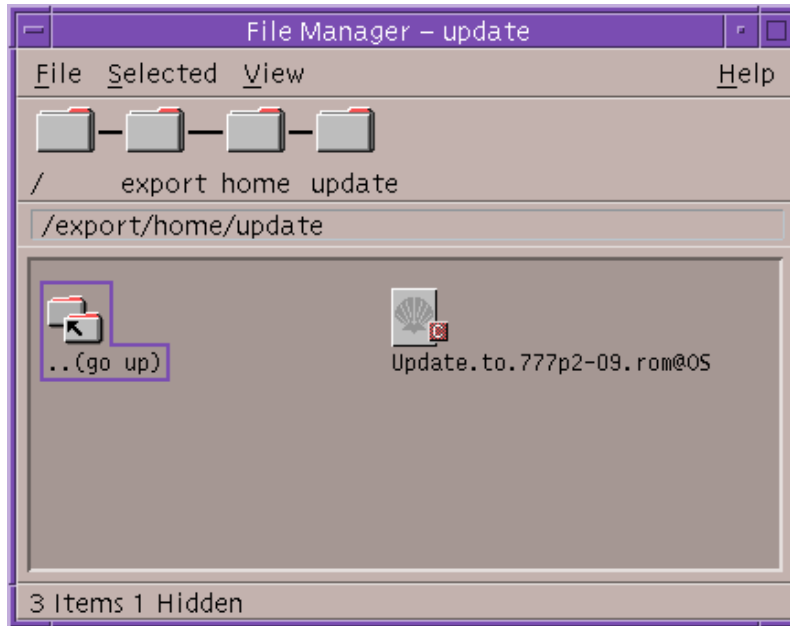

In the meantime, Run Window will pop up and show you the message as Figure below.

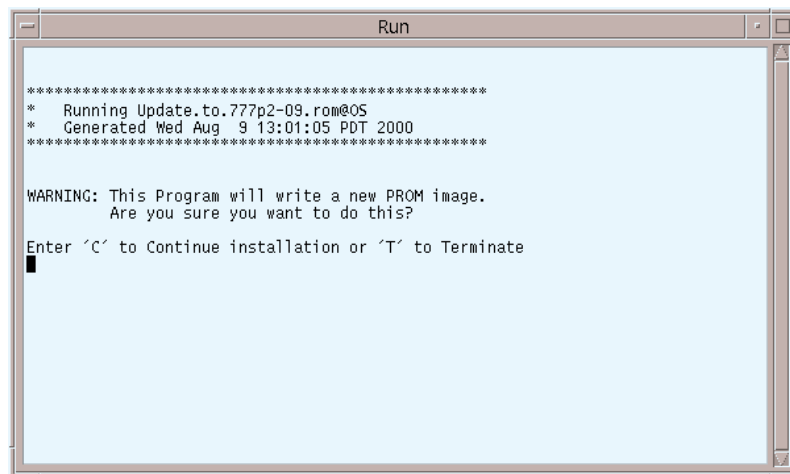

Enter C and press Enter to continue installation.

---

Note – C and T are Case-Sensitive, Please make sure Caps Lock is enabled.

---

After you enter C to continue installation, this program is writing a new ROM image as Figure below. When updating is successfully, please reboot again to take effect.

```
Run
*****
* Running Update.to.777p2-09.rom@OS
* Generated Wed Aug 9 13:01:05 PDT 2000
*****

WARNING: This Program will write a new PROM image.
Are you sure you want to do this?

Enter 'C' to Continue installation or 'T' to Terminate
C
Stripping bundled file: done
Decoding and untaring: done
Verifying checksums: done
Installing flashprom driver file: done

WARNING: Updating Flash PROM with new system firmware in progress...
It may take a few minutes.
***** DO NOT INTERRUPT OR POWER-DOWN THE SYSTEM *****

Updating Netra AX1105-500 PROM
1 Erasing ... Done.
1 Verifying Erase ... Done.
1 Programming ... Done.
1 Verifying Program ... Done.
***** Update.to.777p2-09.rom@OS Completed Successfully

*****
* NOTE: updated Firmware takes effect after next reboot or *
* Power cycle of the system. *
* If there is any configuration support to become effective, *
* you have to use -r with your boot command *
*****
```

**Caution**

DO NOT INTERRUPT or POWER-DOWN the system when updating Flash PROM in progress. Otherwise, you may damage the system and make it cannot boot up.



## Chapter 11 Troubleshooting

This chapter provides information for troubleshooting that may arise with your 777S. It describes how to obtain technical assistance, provides a solution checklist, describes how to use the OpenBoot diagnostics software, and how to solve some common software problems.

## 11.1 Getting Help

If you are unable to diagnose the problem yourself, you can obtain technical support from your system administrator, from your supplier, or from Naturetech Customer Support.

### 11.1.1 Contacting Customer Support

---

Customer Support can be contacted by telephone or Email.

Telephone: TAIWAN : +886-2-2268-9901 ext 257

Email: TAIWAN : [support@naturetech.com.tw](mailto:support@naturetech.com.tw)

In addition technical support information is provided on our website at the following URL : <http://www.naturetech.com.tw>

Prepare problem description information before you call. This will assist us to find a solution to your problem as quickly as possible:

- Machine model and serial number (from the base of the unit).
- Machine configuration (what peripherals are connected).
- For networking problems, a brief description of your network.
- A description of the problem and any steps you have taken to solve it.
- Any warning messages or output you have observed.
- Any codes displayed in the status display.

## 11.2 Problem description & solution

### 11.2.1 Startup Problems

No startup beep, main display is blank, status display is blank, green LED is not lit

Possible Cause	What to Check or Action to Take
The battery is not installed or is installed incorrectly.	Check the power system first. Check that the battery is correctly installed.
The battery is discharged.	Plug-in AC adapter and power on system.
The AC adapter is faulty.	Contact your reseller to replace a new one.

Failed to boot operating system, main display OK, and status display OK

Possible Cause	What to Check or Action to Take
Hard drive is not appeared.	<ol style="list-style-type: none"> <li>1. Use "probe-ide" command in the ok prompt to check primary hard drive status</li> <li>2. Check the hard drive cable</li> </ol>
Network configuration problem. This means your 777S is looking for a name server to which it has no connection.	Reset and restart your 777S as follows: <ol style="list-style-type: none"> <li>1. Press Power button.</li> <li>2. When the OpenBoot welcome message is displayed, press FN-Stop-A. The OpenBoot ok prompt is displayed.</li> <li>3. At the ok prompt, enter the following commands: ok boot -r</li> </ol>

## 11.2.2 Network Problems

Unable to communicate over the network

Possible Cause	What to Check or Action to Take
Faulty transceiver or transceiver cable.	Check basic Ethernet communication using the ping command. For example: # ping systemname/IP address
Bad connection to Ethernet cable or un-terminated Ethernet cable.	If the communications path is operating a message will be returned: Systemname/IP address is alive The message will not displayed If there is hardware or configuration problem. If it's no response for a while, you may terminate it with the Ctrl-C interrupt command. If ping fails there may be a basic hardware or software configuration problem and you should check the hardware interfaces and the basic software setup.
Entry for remote system not in local /etc/hosts or entry for your system not in remote /etc/hosts.	
Cannot find name server or name service configuration files or they contain incorrect information.	Ask for help from an experienced network administrator about specific configuration requirements for you location.
Internet addresses incorrect or duplicated.	
No write permission to requested resources.	

## 11.3 Hardware Problems

### 11.3.1 Display Problems

Possible Cause	What to Check or Action to Take
External display blank.	External display interface not enabled.
Garbled display.	Wrong display timing parameters set.

### 11.3.2 I/O Problems

Possible Cause	What to Check or Action to Take
External keyboard or mouse does not work.	<p>Check that the external mouse or keyboard are compatible types and are connected to USB port properly.</p> <p>Check if the keyboard and 777S are communicating by using the command <code>kbconfig -r</code>. The keyboard LEDs should light.</p> <p>In the case of an optical mouse you can see if it is powered by checking to see if the red LED on the underside of the mouse is illuminated.</p>

## 11.4 Using The OpenBoot Diagnostics tool

OpenBoot is an industry standard (IEEE1275) ROM-based firmware implementation that controls your 777S between the time it is powered on and the Solaris™ operating system takes control. During this time OpenBoot carries out the hardware testing and initialization before booting the operating system.

OpenBoot also provides a user interface and programming language, based on Forth, which can be used to perform diagnostics and change user-configurable options stored in NVRAM.

---

### 11.4.1 Displaying The OpenBoot User Interface

---

Display the OpenBoot user interface as follows:

1. Power on your system.

When the OpenBoot start-up screen is displayed, press FN-Stop-A. The OpenBoot ok prompt is displayed.

---

### 11.4.2 Checking IDE devices

---

To check IDE devices configuration, enter the following command:

**ok probe-ide**

This command will display a list of IDE devices for your 777S.

```
Device 0    (Primary Master)
            ATA Model: IBM-DJSA-220
Device 1    (Primary Slave)
            Not Present
Device 2    (Secondary Master)
            Removeable ATAPI Model: TOSHIBA DVD-ROM SD-C2402
Device 3    (Secondary Slave)
            Not Present
```

If there is any IDE devices do not list, you may use test command to check IDE devices. To test the internal IDE hardware, use the following commands:

```
ok setenv diag-switch? true
```

```
ok test ide
```

Disable diagnostics again using the following command:

```
ok setenv diag-switch? false
```

---

### 11.4.3 Checking The Network Interface

---

The following command allows to checking the status for Ethernet interface:

```
ok watch-net
```

```
gme register test -- succeeded.
```

```
Internal loopback test -- succeeded.
```

```
Link is – Using Onboard Transceiver – Link Up.
```

```
up
```

```
Using Onboard Transceiver – Link Up.
```

```
Looking for Ethernet packets.
```

'.' is a good packet. 'X' is a bad packet.

Type any key to stop.

.....

A series of periods (...) should be printed rapidly across the screen if the internal hardware and Ethernet connection are functioning correctly. If you are still having network problems, you should check your network configuration.

#### 11.4.4 Full System Hardware Self test

Carrying out a full system self test with OpenBoot entails the following basic steps:

- Connecting an ASCII terminal to one of the serial ports on the rear of 777S.
- Configuring OpenBoot to enable diagnostics and terminal I/O.
- Entering the selftest command.
- Connecting an ASCII terminal

You can connect an ASCII terminal to either of the serial ports.

The terminal should be configured for 9600 baud operation, 8 bits, no parity and no handshaking.

##### Enabling Terminal I/O

Enter the following commands to configure OpenBoot to enable diagnostics. Use the serial channel as the input and output devices and to inhibit auto-booting:

```
setenv diag-switch? true
setenv output-device ttya
setenv input-device ttya
setenv auto-boot? false
```

Note – The last command will prevent your 777S from automatically booting the operating system when you power on (the normal mode of operation). You must reverse these commands, as described below, to re-enable normal start-up operation.

Now reset your system by reboot. Your 777S should display a long sequence of messages on the terminal followed by the ok prompt. If the ok prompt is not displayed, try pressing Return on the terminal's keyboard

a few times. If it is still not displayed, press FN-Stop-A on the keyboard type following command:

```
ttya io
```

If the ok prompt still does not appear, contact customer support or your supplier for assistance.

- Carrying out the Hardware Self test

To test the internal devices, type:

```
ok test-all
```

The results of the tests will be displayed on the terminal. If any devices fail, contact your supplier for further assistance.

- Re-enabling Normal Operation

To re-enable normal operation, enter the following commands:

```
setenv diag-switch? false
```

```
setenv output-device display
```

```
setenv input-device keyboard
```

```
setenv auto-boot? true
```

To make the changes take effect, press Power button to power down and then press Power button to power on again.

## 11.5 Software Problems

The operating system controls the peripherals and is, therefore, a critical component in enabling the 777S to operate correctly. For example, a minor error in a network configuration file can completely prevent the network interface from operating.

This section provides some information on common software problems and gives brief advice about possible remedies in each case. By its very test it cannot be complete and situations may arise where you need the help of an experienced system administrator or Naturetech Customer Support.

### 11.5.1 Stopping Processes

---

To stop the processes, press the interrupt character Ctrl-C. This normally causes a program to exit. However, not all programs recognize or act on the interrupt in which case you need to kill the process in order to halt it, as described in the next section.

---

### 11.5.2 Killing a Program

---

Before killing a process, you must know its process ID number (PID). To determine this, display a summary of all user processes with the following command:

```
# ps -ef
```

Make a PID note of the program you wish to kill. For example, the following output shows a program called demo running with a PID of 7363:

PID	TTY	TIME	CMD
7361	pts/4	0:00	ps
7339	pts/4	0:00	sh
7363	pts/4	0:00	demo

To kill the demo process, you would type:

```
# kill -9 7363
```

The -9 specifies that the process should be killed regardless of what it is doing. If you do not own the process, you will need to become superuser to carry out this step.

---

### 11.5.3 Operating System Panic

---

If there is any hardware or a software fault, the operating system may panic. This occurs when the operating system encounters a serious problem and it cannot continue to run the machine. If the system panics, a message will be printed on the screen: together with as much information as the operating system is able to gather about the cause. You should record the information for subsequent use by Customer Support. The system may reboot automatically reset due to this reason, as described below.

#### Failing Program

Programs can fail to be executed for a variety of reasons, some conventional problem are as follows:

- Corrupt program
- The disk copy of the program has been corrupted.
- Shared library inconsistency

The program was compiled with a shared library that is incompatible with the 777S. Use the "ldd" utility to determine what libraries a program is loading. This problem can only be resolved by re-link the application with

the shared libraries.

### **Program Error**

A programming fault can cause a segmentation violation if, for example, a program attempts to write to an illegal or protected address.

### **Out of Swap Space or Memory Space**

A message may display on the console if each of the condition occurs. If you are running OpenWindows, the server may suddenly exit, return to the terminal interface.

### **Memory failure**

There has been a memory error (hardware) during program execution. The Solaris™ operating system includes the trace utility that allows you to monitor the system calls made by a process. An experienced UNIX programmer may use to track down the cause of a problem. In addition, experienced UNIX programmers may be able to use the crash, adb or dbx debugger utilities provided to determine the cause of a core dump.

## **11.5.4 Warning Messages**

---

The Solaris™ operating system often prints system information in the form of warnings. The warning message only inform you some illegal operation may cause some problem, it will remind you to notice may something wrong with the file system.

Warning messages are generally displayed in the console window but may also be displayed in a command tool or application window.

Some messages may indicate that the system is out of resources and require attention. For example, a program may fail to start or may print a message such as:

```
out of swap space
or out of memory
or FS full on /dev/c0t0d0s6
: cannot write %xyx
```

As a rule you should exit the offending program in this. It may be prudent to reboot the operating system after such an event because applications and the operating system do not always recover from resource failures gracefully.

If you run out of disk space you must either move files to a different filesystem, or to a networked server, or you must remove them.

## 11.6 Resetting 777S

If the operating system locked up, you may have to reset the 777S. Shutdown system and then power on again.

A reset should only be used as a last resort because the operating system will have open files and unflushed buffers that will have to be repaired when the system is rebooted.

After resetting system, your 777S performs a complete Solaris™ reboot and run the automatic filesystem check program (fsck). After completing the fsck, the system either automatically reboots, or may complete a single user start-up sequence and issue the # prompt.

In the latter case type Ctrl-D to continue the normal boot sequence.